

Chapter 10

Section A

Enlisted Career Progression Charts

10-1-1. General

This chapter contains career progression charts for each enlisted career management field (CMF) and approved for enlisted classification.

10-1-2. Specifications for Enlisted Career Progression Charts

This chapter contains career progression charts for each enlisted specialty. The chapter is organized by each CMF and defined as CMF XX where XX represents the enlisted CMF. For example the specifications for CMF13, Field Artillery are located in section CMF 13.

**Table 10-1-1
MOS Substitution**

CMF	Substituting MOS	Substituted MOS
11	11C	11B
12	None	
13	None	
14	None	
15	None	
17	None	
18	None	
19	None	
25	None	
27	None	
29	None	
31	None	
35	None	
36	None	
37	None	
38	Any; Must be E-5 with 5 Yrs Service	38
42	42T	79R (NOFC 2510-07)
46	46V1O (Eff 202210)	46S1O
51	None	
56	None	
68	68	Any CMF 68 MOS can serve as First Sgt, Operations, Intel/plans, Tng, IG, EOA, or Det Sgt at the MSG and SFC levels
74	None	
79	None	
88	None	
89	89A and 89B	At skill level 1 only and if 89B previously performed Ammunition Stock Control & Accounting Specialist duties prior to Oct 2007
91	91F	91K
92	92A5M	92Y5M

92	92Y5M	92A5M
94	None	

Army
Equestrian

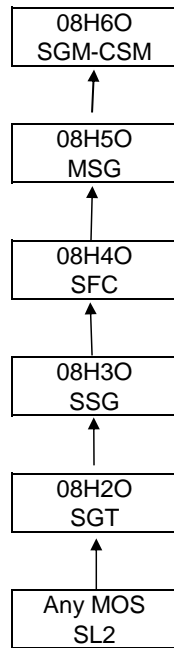

SUBSTITUTABILITY: NONE



Line of normal progression.

Figure 10-08. MOS 08H - Army Equestrian Career Progression (Effective 202603)

	Indirect Fire	Infantry	Command
	Infantryman	Senior	Sergeant
	Infantryman	Sergeant	Major
			Nominative

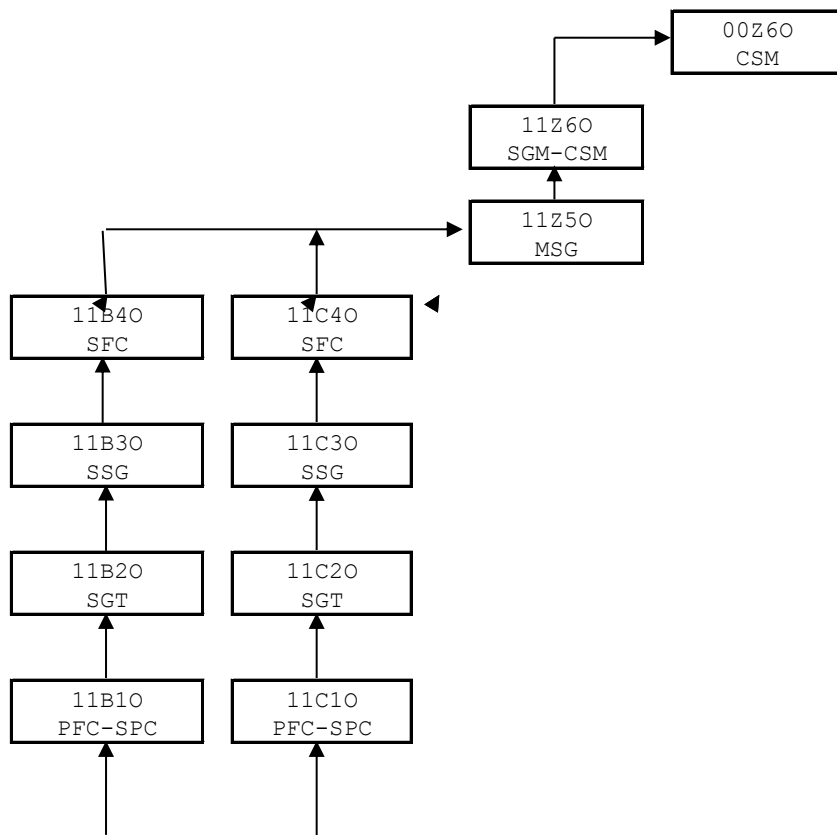

SUBSTITUTABILITY: 11C for 11B ◀

Figure 10-11. CMF 11 - Infantry career progression (Effective 1110)

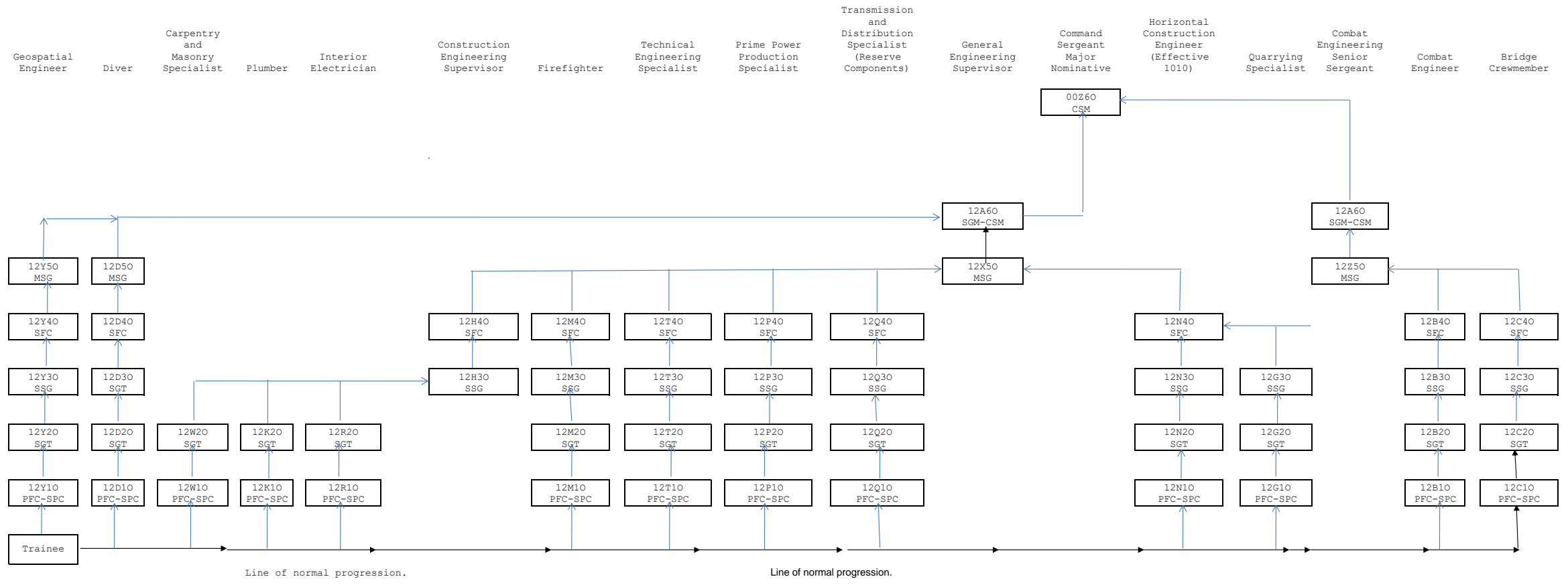

10-12a CMF 12 - Enginner career progression (Effective 202310)

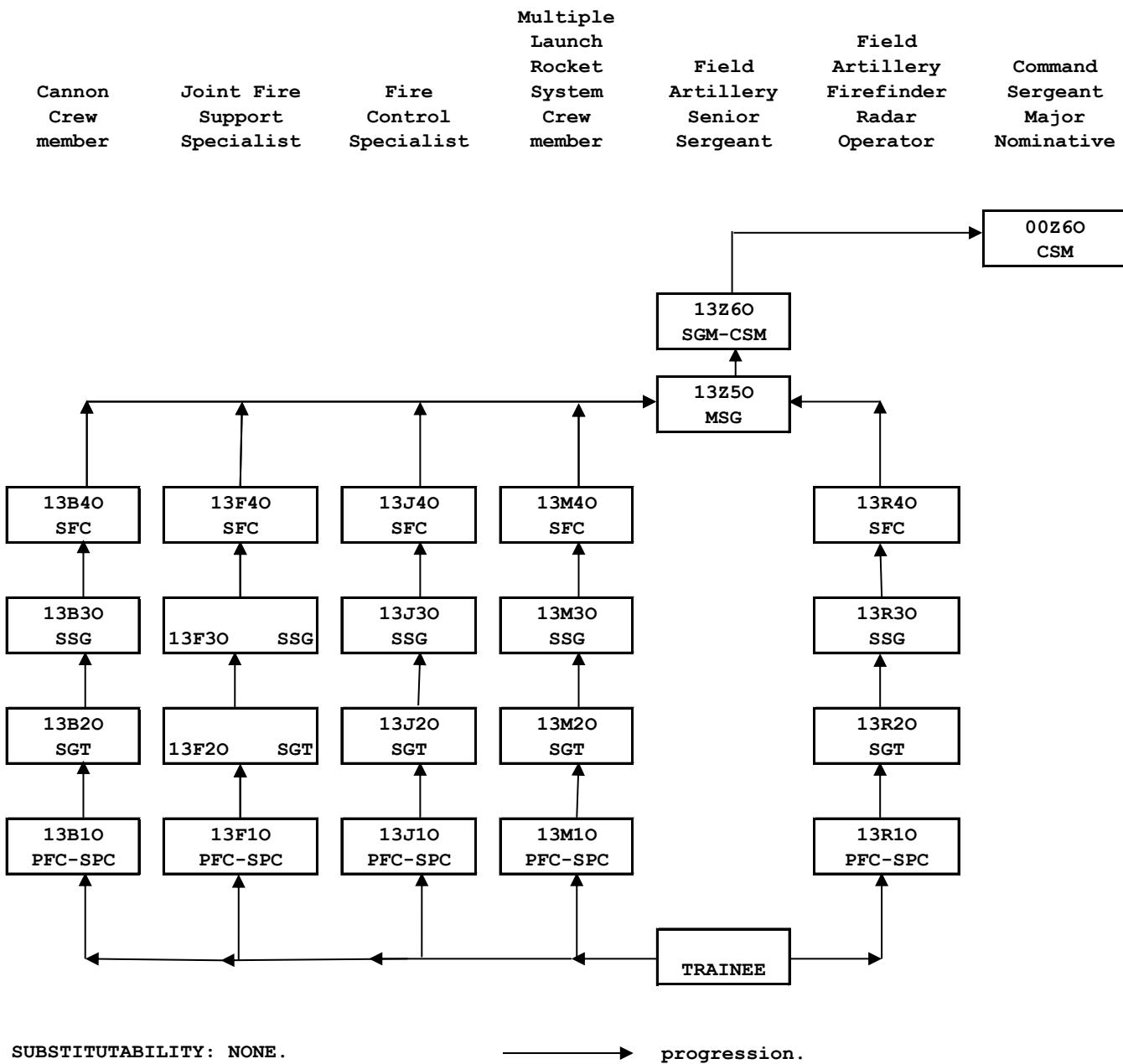

Figure 10-13a. CMF 13 - Field Artillery career progression (Effective 201710)

Patriot Fire Control Enhanced Operator/ Maintainer	Air Defense Battle Management System Operator	Air Defense Enhanced Early Warning Operator	Air Defense Artillery Senior Sergeant	Air and Missile Defense Crewmember	Patriot Launching Station Enhanced Operator/ Maintainer	Command Sergeant Major Nominative
--	---	--	--	---	--	--

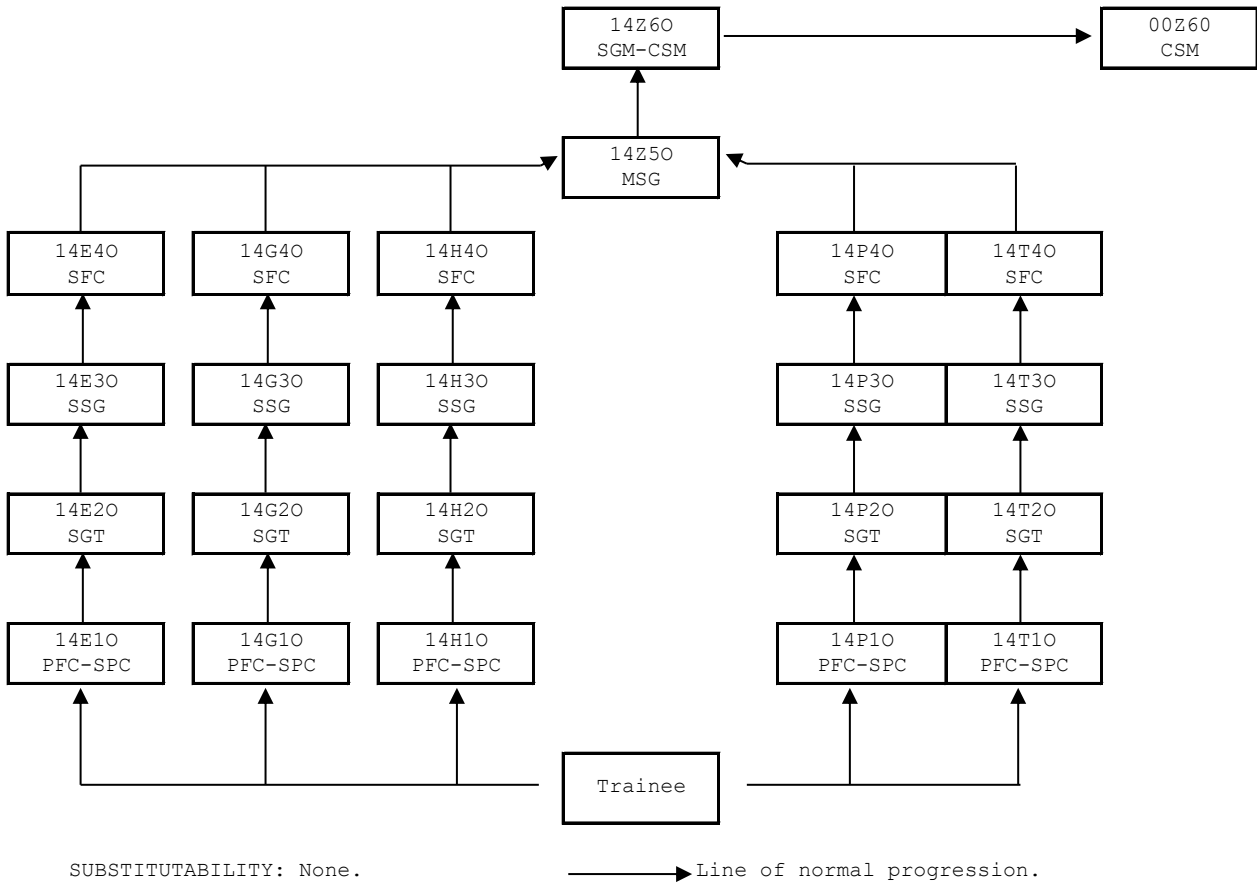

Figure 10-14. CMF 14 - Air Defense Artillery career progression (Effective 202510)

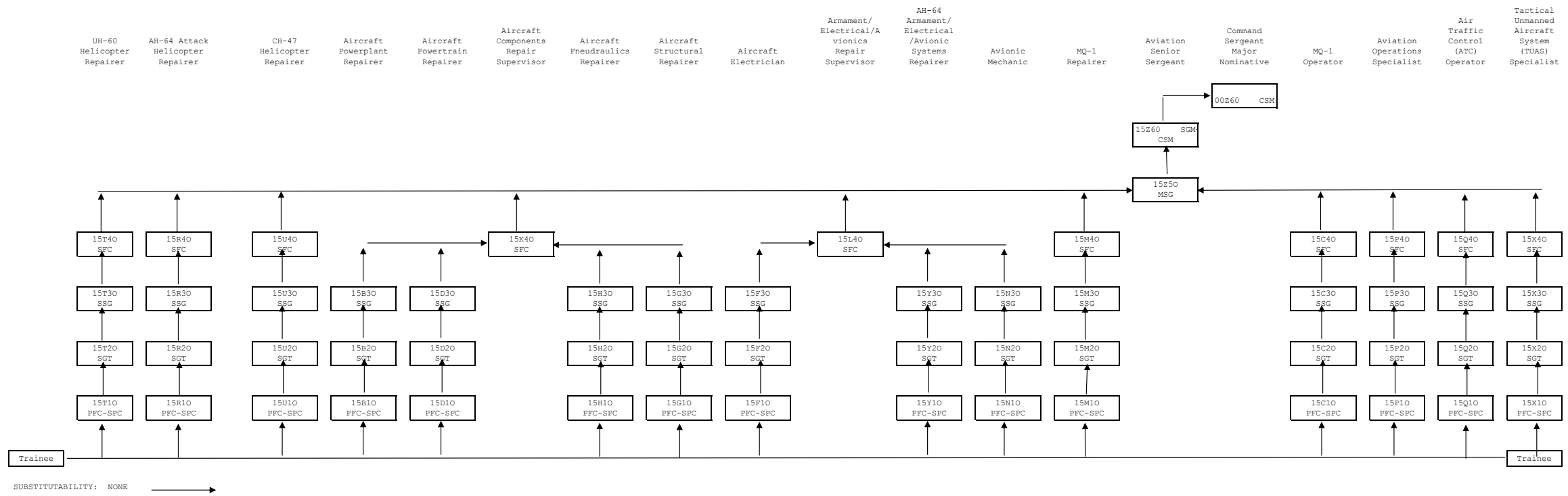

Figure 10-15 CMF 15 - Aviation career progression Effective 202610

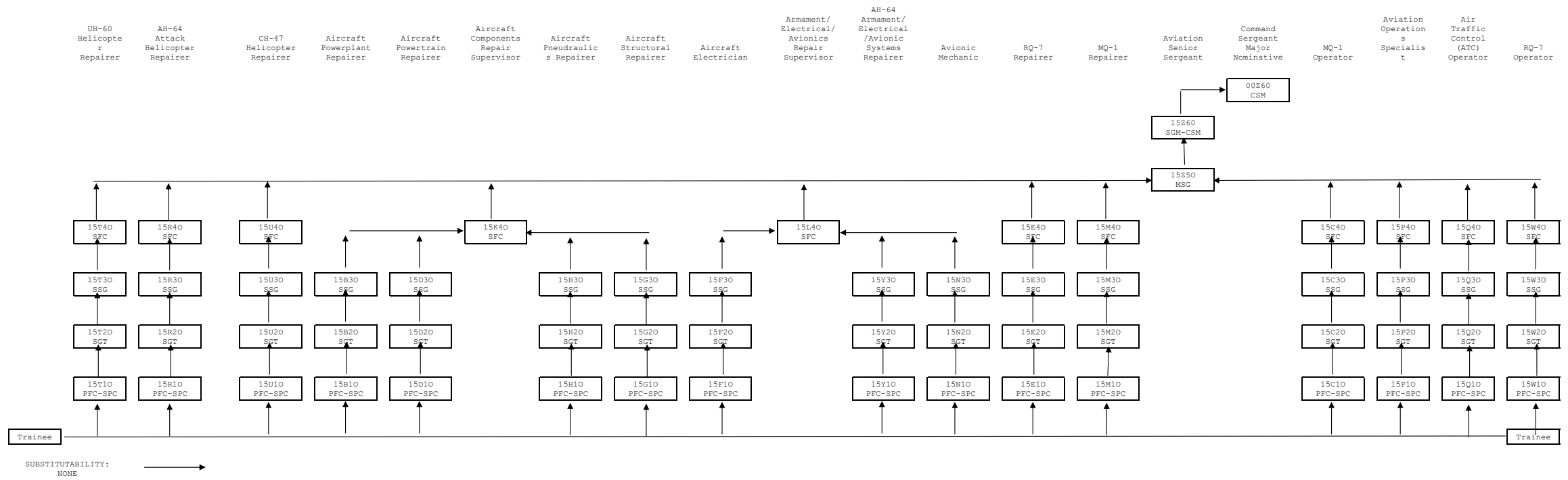
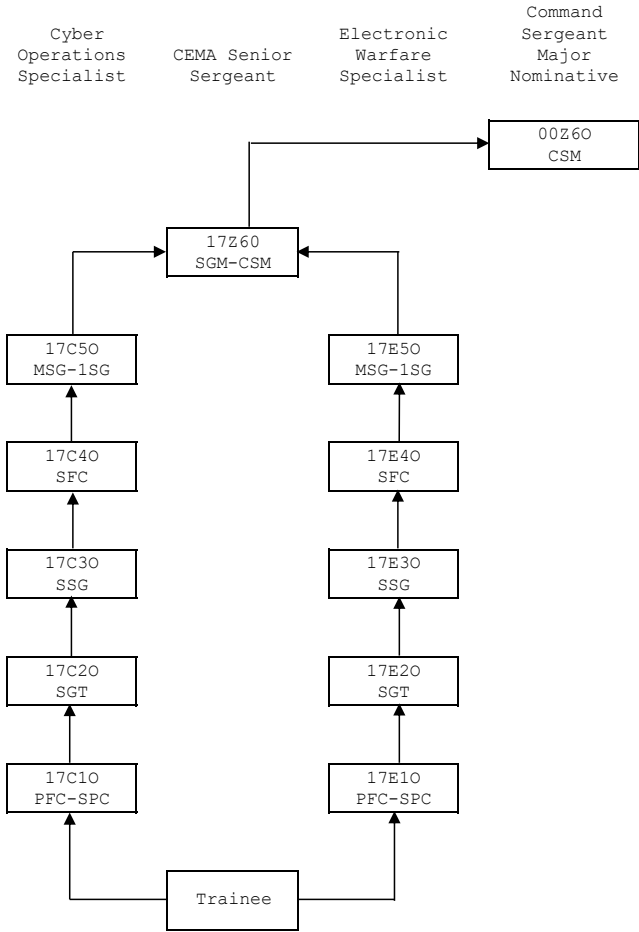

Figure 10-15 CMF 15 - Aviation career progression Effective 202110



SUBSTITUTABILITY FOR 17C: None

Figure 10-17. CMF 17 Cyber Career Progression (Effective 202210)

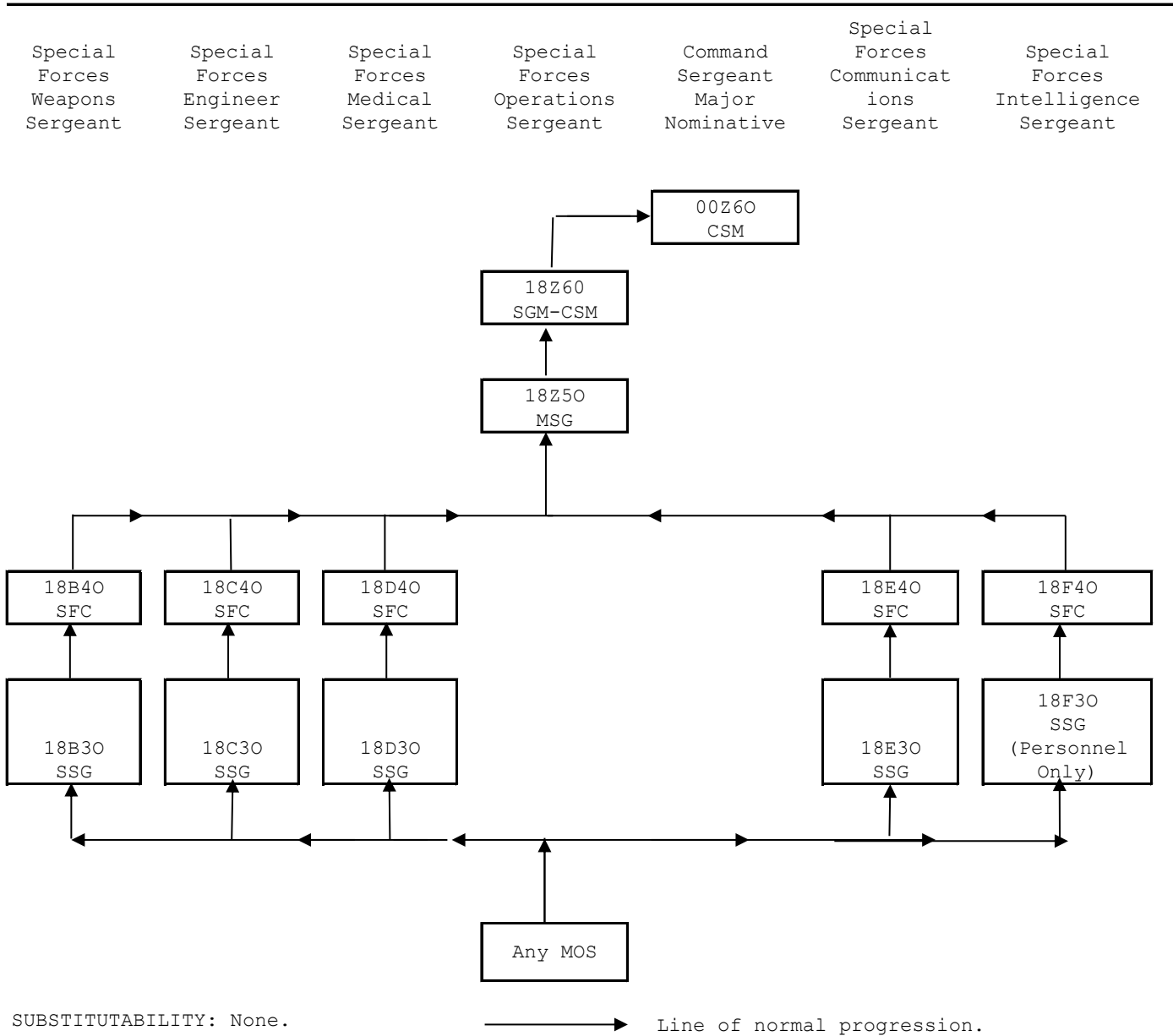
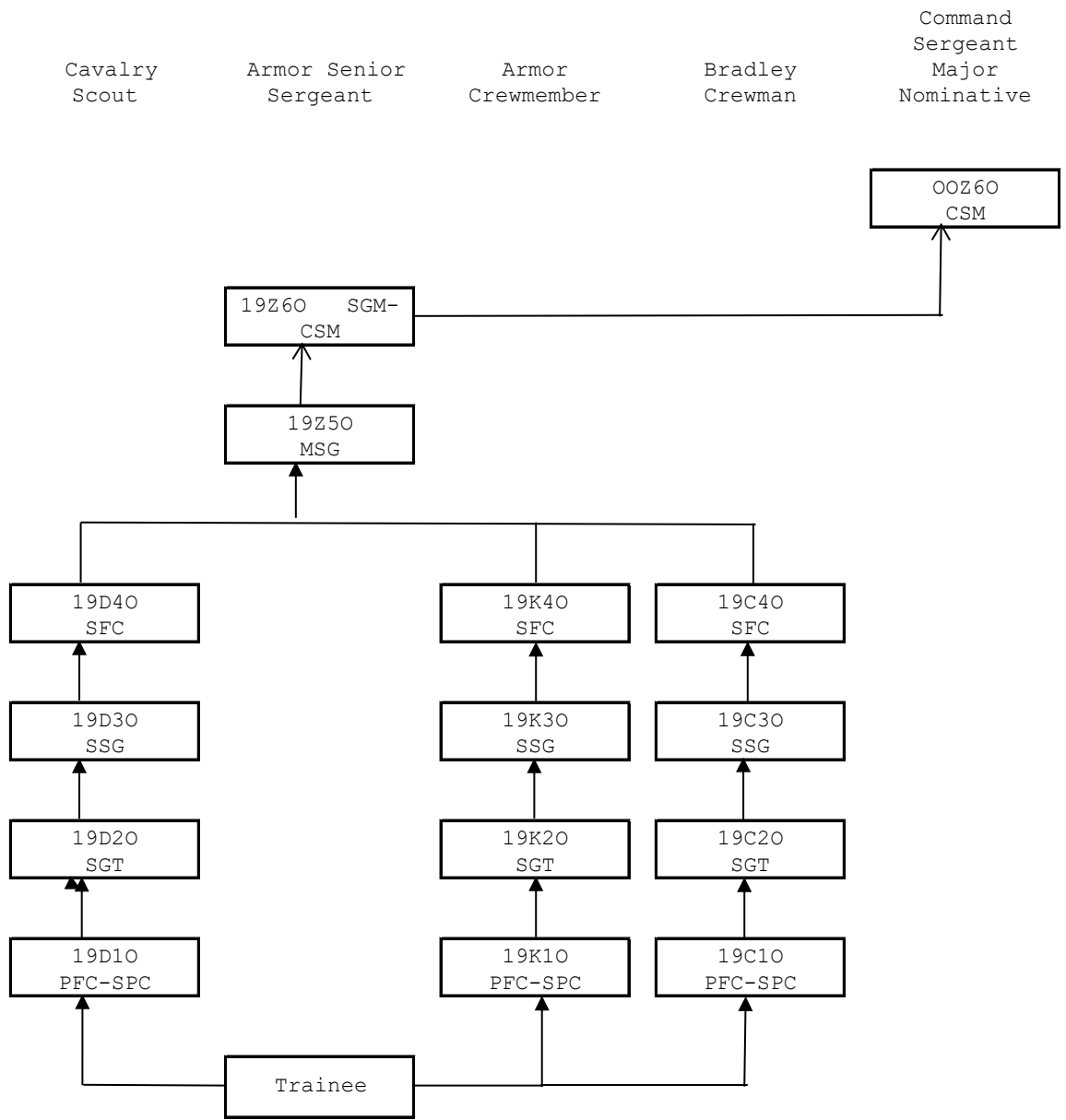

Figure 10-18. CMF 18-Special Forces career progression (Effective 202208)



SUBSTITUTABILITY: None.

—————> Line of normal progression.

Figure 10-19. CMF 19 - Armor career progression (Effective 202410)

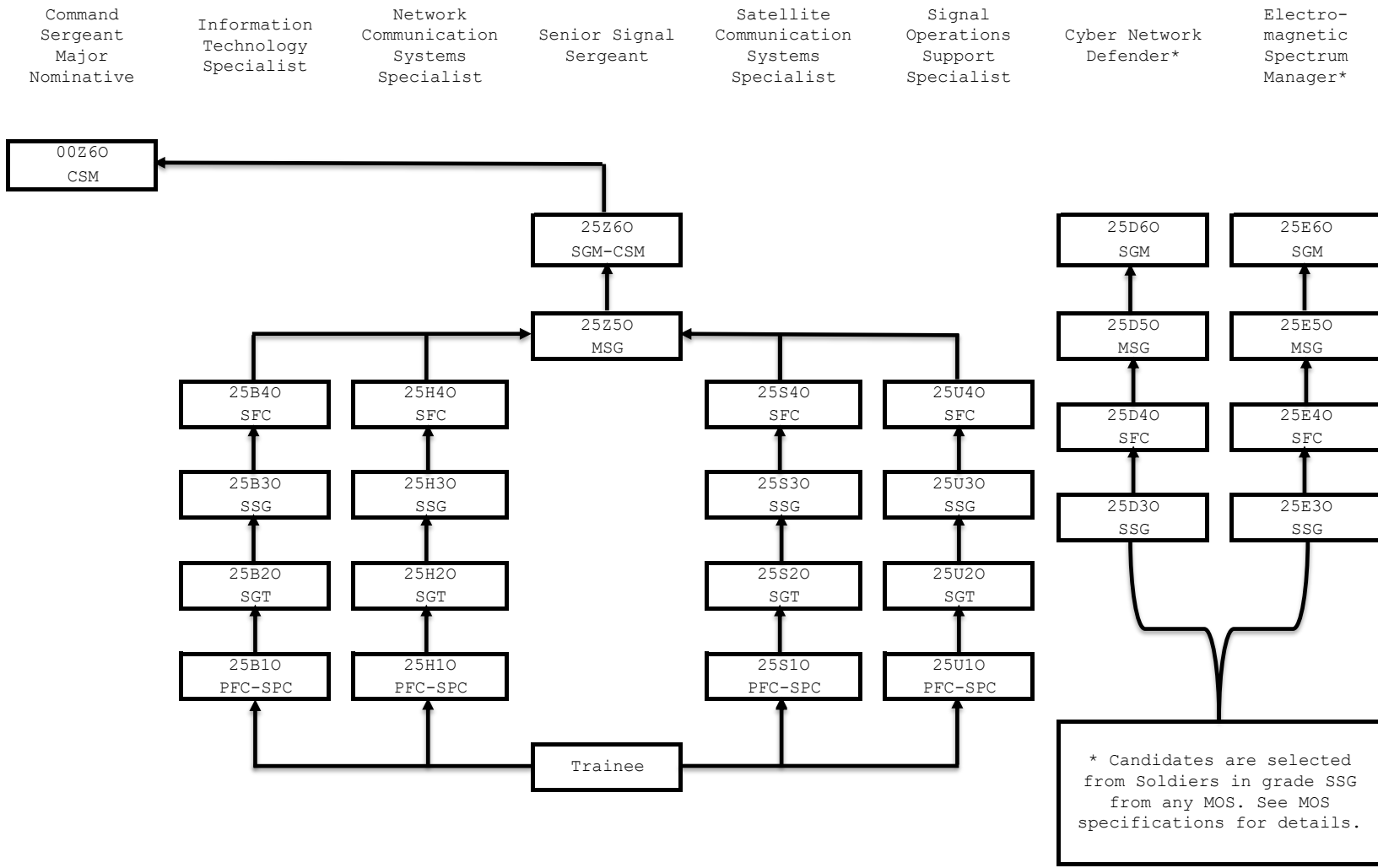

SUBSTITUTABILITY: None

Figure 10-25a. CMF 25--Signal career progression (Effective 202510)

Paralegal
Specialist

Command
Sergeant
Major
Nominative

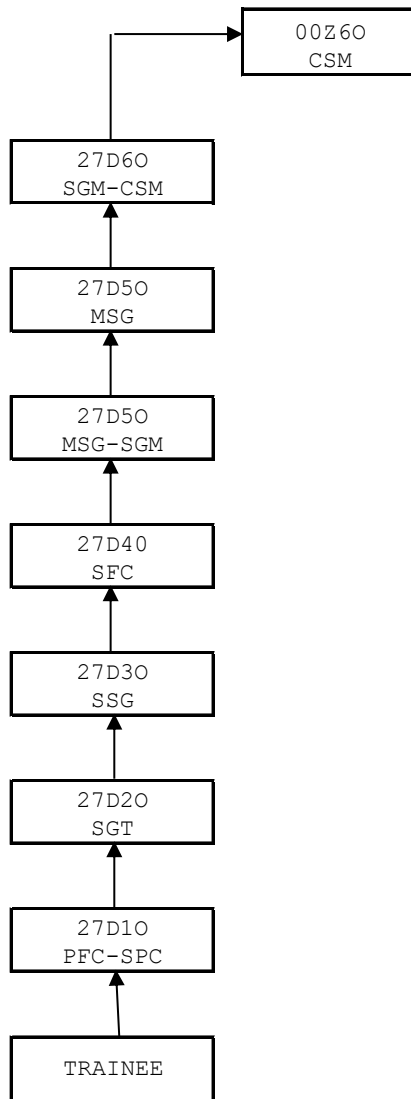

SUBSTITUTABILITY: None.

—————> Line of normal progression.

Figure 10-27. CMF 27--Paralegal career progression. (Effective 201110)

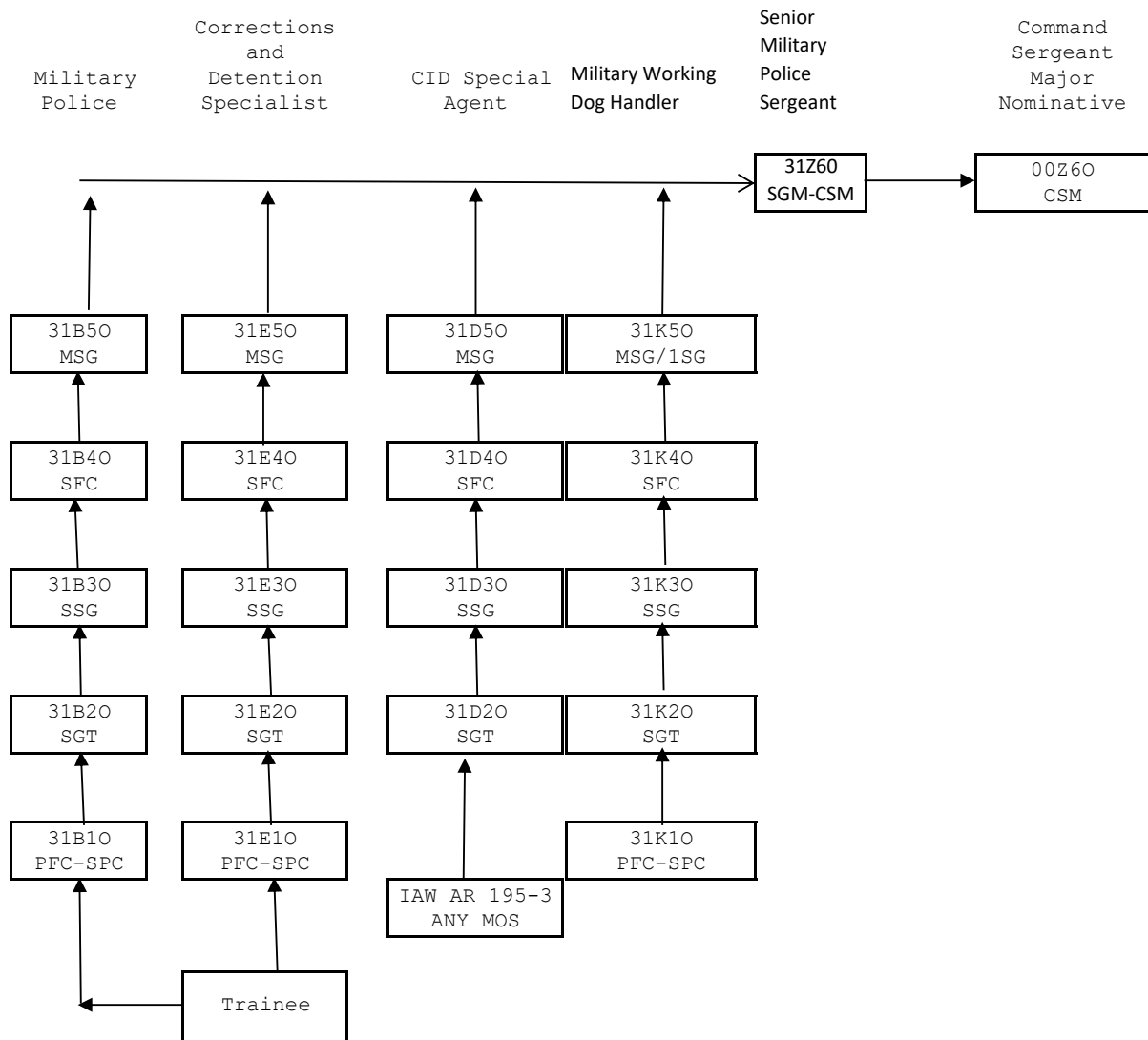

SUBSTITUTABILITY: None.

→ Line of normal progression.

Figure 10-31. CMF 31 - Military Police career progression (Effective 202010)

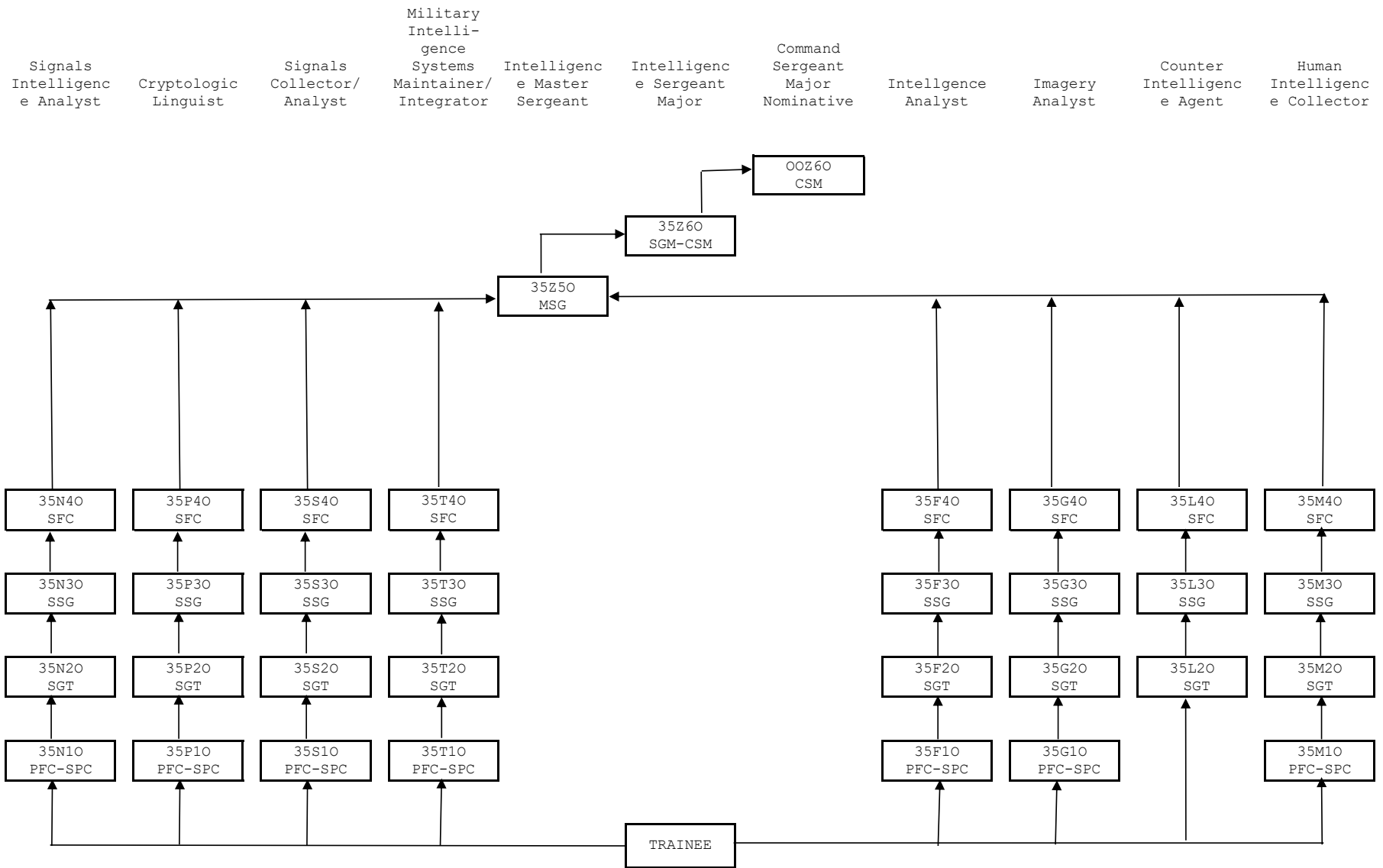

SUBSTITUTABILITY: None

Line of normal progression.

Figure 10-35. CMF 35 - Military Intelligence career progression (Effective 20201001)

Financial
Management
Technician

Command
Sergeant
Major
Nominative

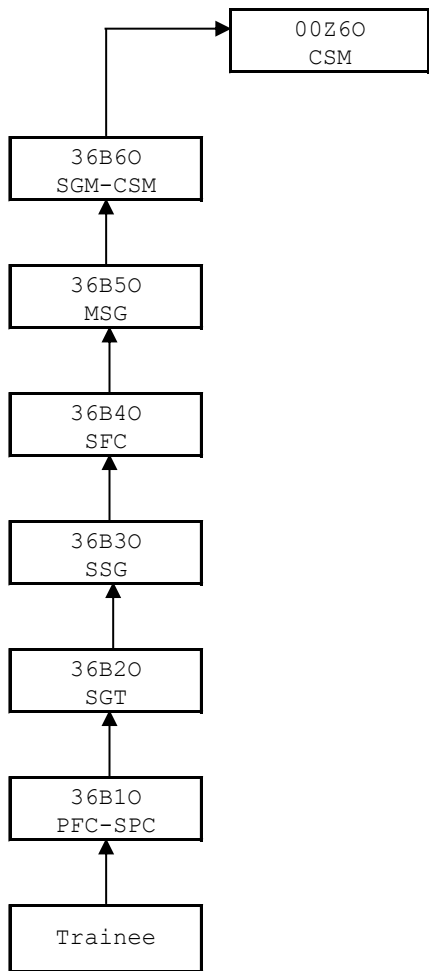

SUBSTITUTABILITY: None.

—————> Line of normal progression.

Figure 10-1. CMF 36--Financial management career progression. (Effective 201110)

Psychological
Operations
Specialist

Command
Sergeant
Major
Nominative

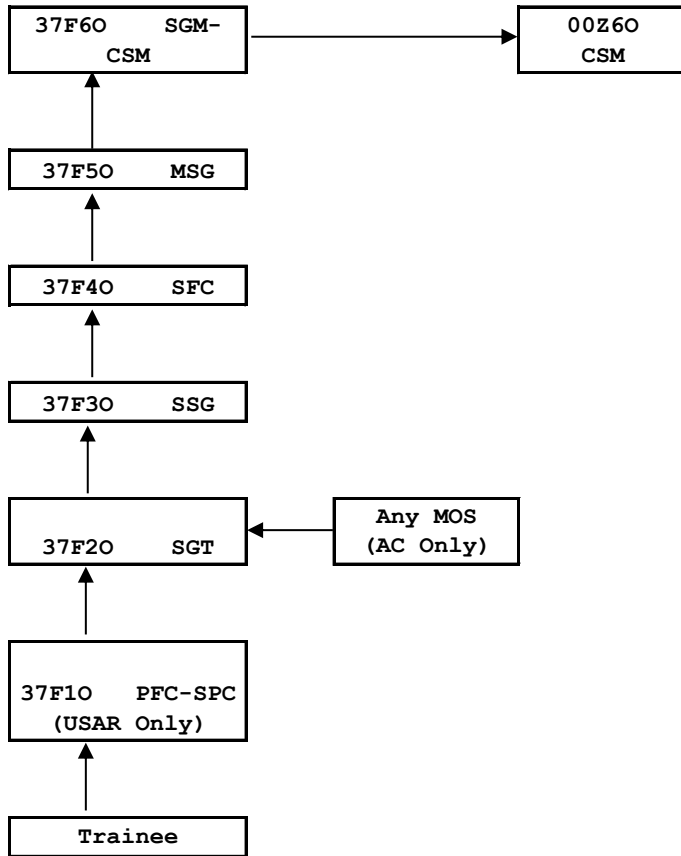

SUBSTITUTABILITY: None.

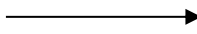

Line of normal progression.

Figure 10-37. CMF 37 - Psychological Operations Career progression (Effective 201910)

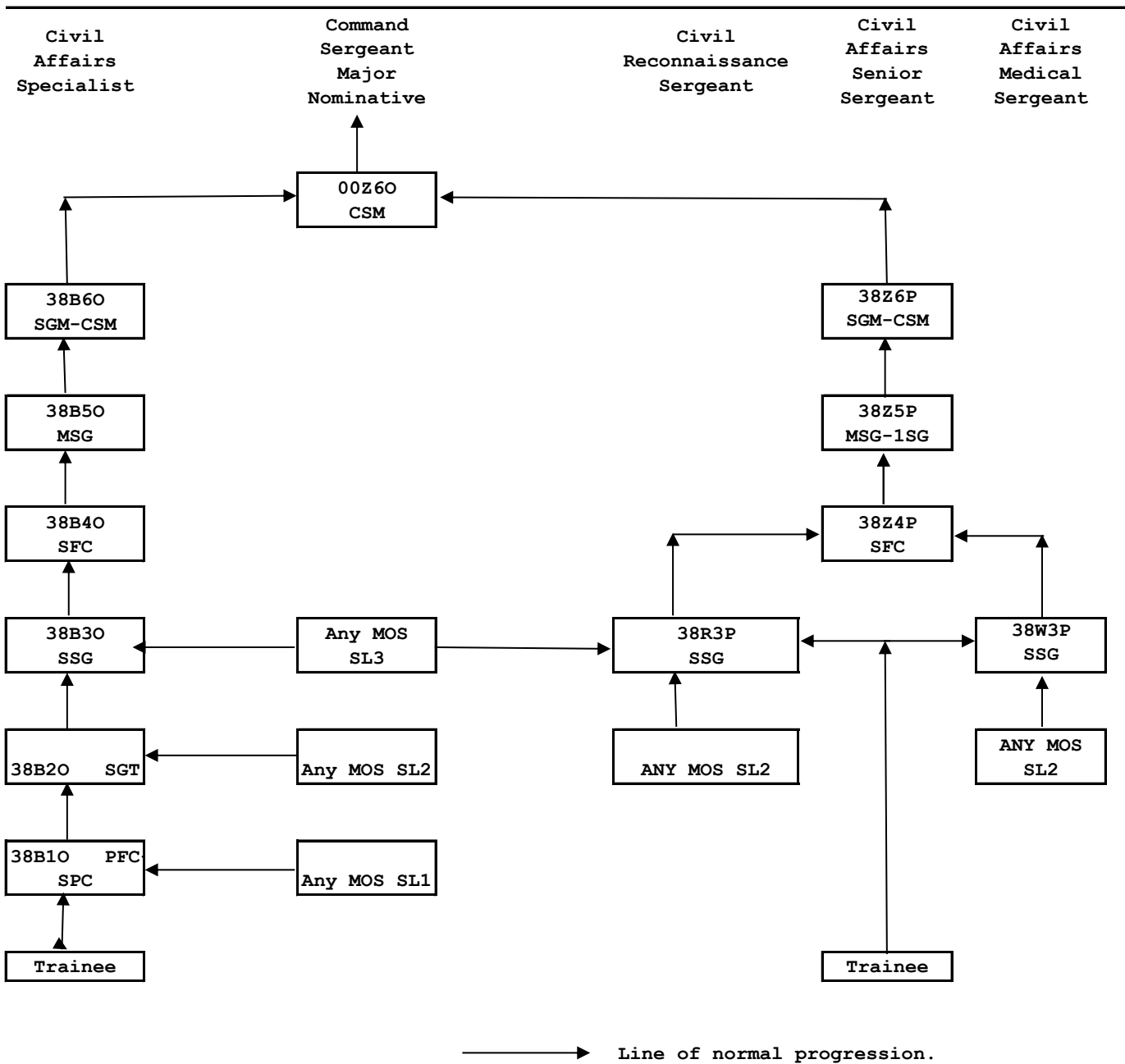

Figure 10-38. CMF 38 - Civil Affairs Specialist career progression (Effective 202310)

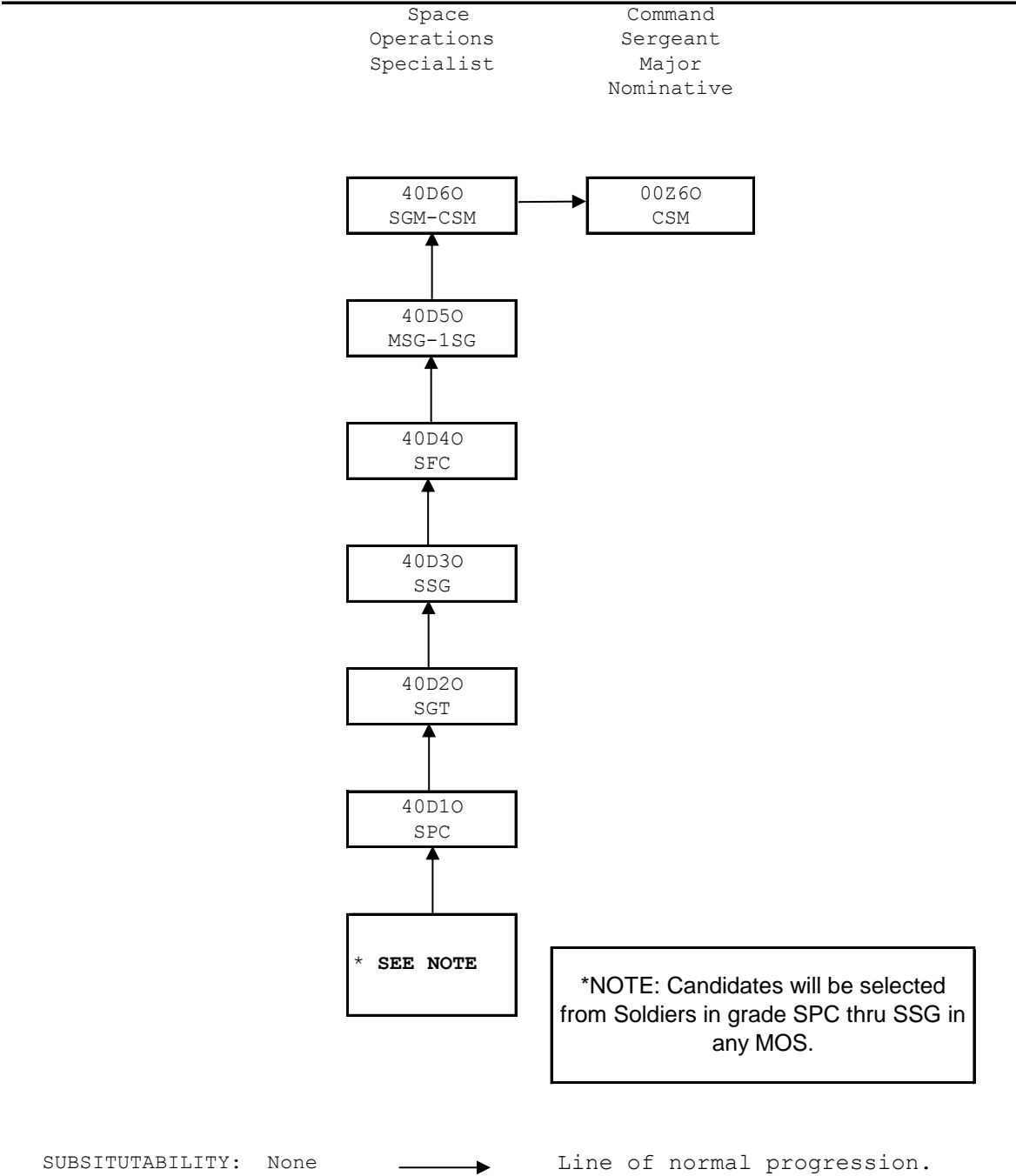
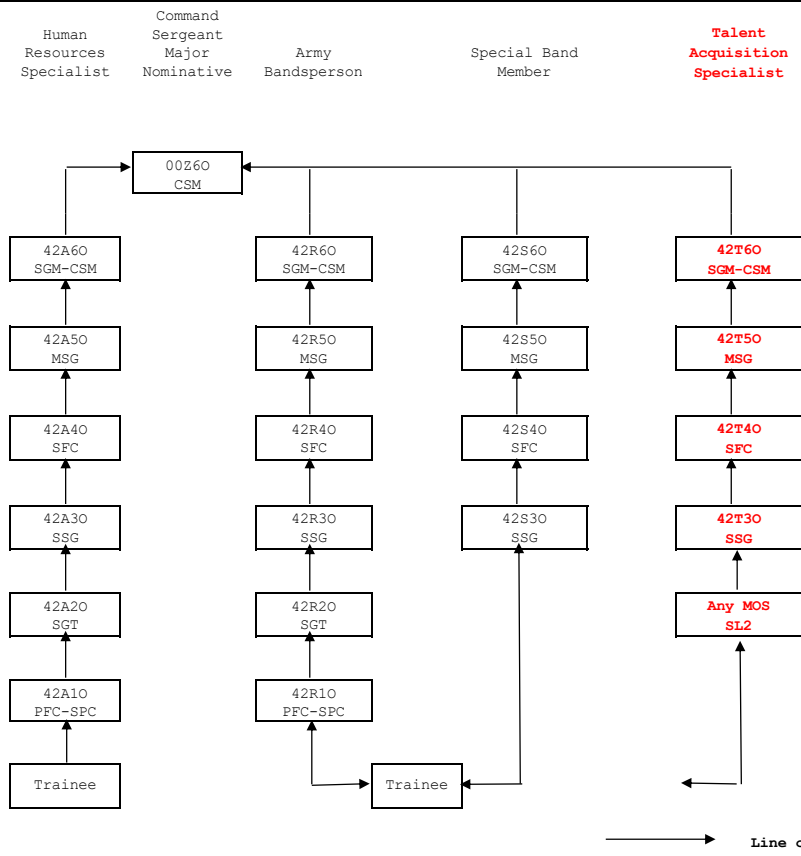

Figure 10-40. CMF 40 Space Operations Specialist Career Progression (Effective 202610)



SUBSTITUTABILITY:
79R to 42T

Figure 10-1. CMF 42--Adjutant General career progression. (Effective 202510)

	Mass Communication Systems Engineer	Visual Information Supervisor	Visual Information Specialist	Command Sergeant Major Nominative
Public Affairs Supervisor				

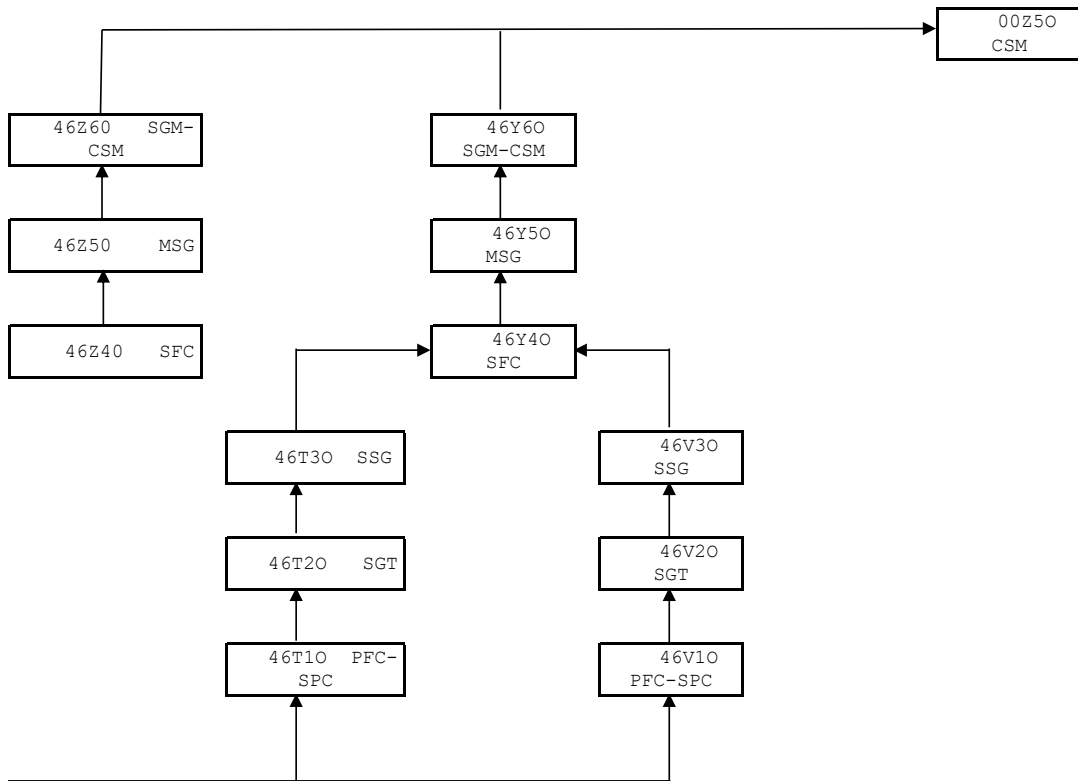

QUALITY: 46V10
46S10

—————> Line of normal progression.

Effective 202610

6a. CMF 46--Public Affairs and Visual Information career progression

Public Affairs Supervisor Visual Information Equipment Operator-Maintainer Visual Information Supervisor Visual Information Specialist Command Sergeant Major Nominative

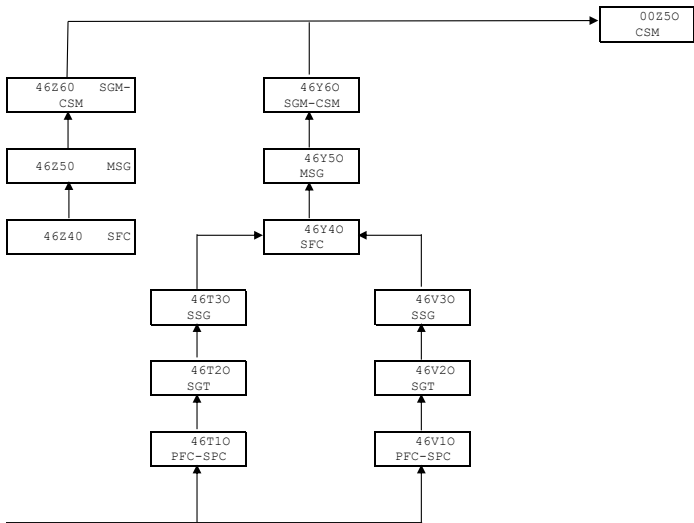

ILITY: 46V10 → Line of normal progression.
46S10

Effective 202210

. CMF 46--Public Affairs and Visual Information career progression

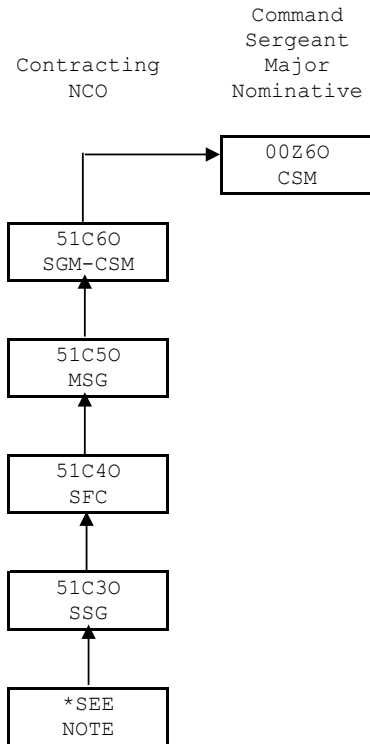

SUBSTITUTABILITY: None.

* SGT through SSG (non-promotable) may request accession into MOS 51C by (DA Form 4187). SM will be coded with ASI 4B until successful completion of MOSQ training at the Army Acquisition Center of Excellence. USAR and ARNG NCOs may alternatively complete Defense Acquisition University (DAU) Level I course in contracting and CON electives to become MOSQ. MOS 51C is not awarded until MOSQ training is successfully completed. Any enlisted MOS is considered a feeder MOS for MOS 51C.

Figure 10-51. CMF 51 - Acquisition, Logistics & Technology career progression (Effective 20180801)

Religious
Affairs
Specialist

Command
Sergeant
Major
Nominative

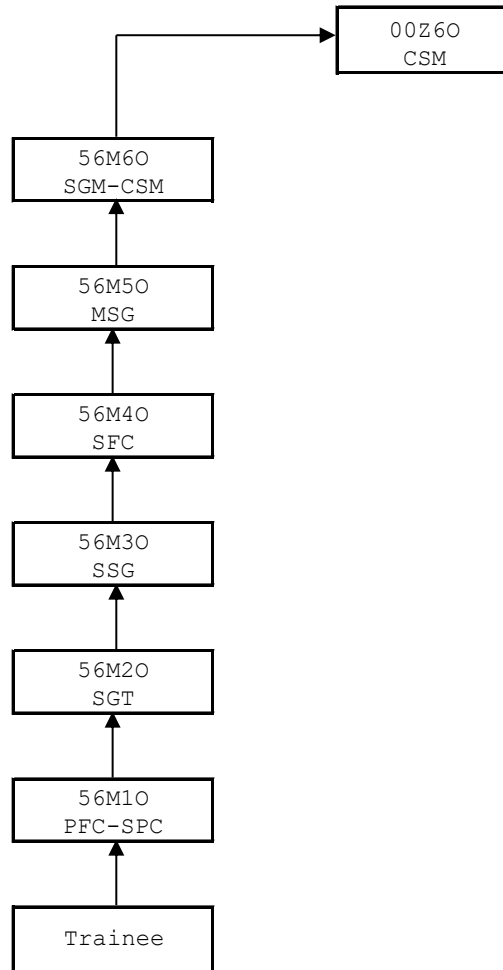

SUBSTITUTABILITY: None.

—————> Line of normal progression.

Figure 10-56. CMF 56--Religious Support career progression.

BIOMEDICAL EQUIPMENT SPECIALIST PRACTICAL NURSING SPECIALIST DENTAL SPECIALIST PATIENT ADMINISTRATION SPECIALIST MEDICAL LOGISTICS SPECIALIST MEDICAL LABORATORY SPECIALIST NUTRITION CARE SPECIALIST RADIOLOGY SPECIALIST PHARMACY SPECIALIST PREVENTIVE MEDICINE SPECIALIST COMMAND SERGEANT MAJOR (NOMINATIVE) CHIEF MEDICAL NCO VETERINARY FOOD INSPECTION SPECIALIST ANIMAL CARE SPECIALIST ORTHOPEDIC SPECIALIST OPERATING ROOM SPECIALIST PHYSICAL THERAPY SPECIALIST OPTICAL LABORATORY SPECIALIST OCCUPATIONAL THERAPY SPECIALIST COMBAT MEDIC SPECIALIST RESPIRATORY SPECIALIST BEHAVIORAL HEALTH SPECIALIST EYE SPECIALIST

00260 CSM
66240 CSM/SGM

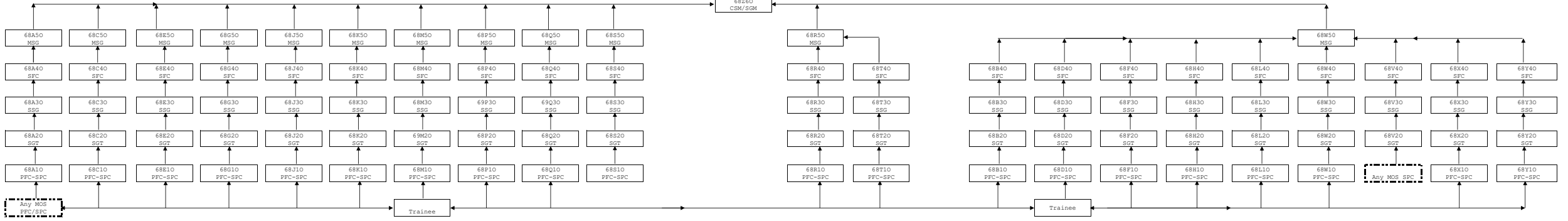

→ Line of normal progression.

SUBSTITUTABILITY: Any CMF 68 MOS can serve in positions of First Sgt, Operations, Intel/plans, Tng, IG, EOA, or Detachment Sgt at the MSG and SFC level only.

Figure 10-68a. CMF 68 - Medical career progression (Effective 202110)

Figure 10-68b. CMF 68 - Medical career progression (Effective 202210)

Chemical
Biological
Radiological
and Nuclear
Specialist

Command
Sergeant
Major
Nominative

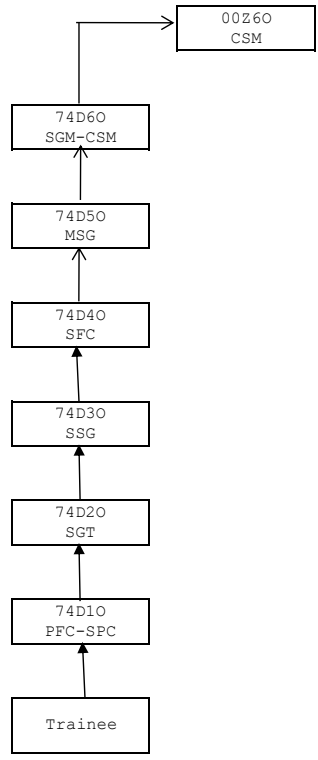

SUBSTITUTABILITY: None.

—————> Line of normal progression.

Figure 10-111. 00Z60 Chemical, Biological, Radiological and Nuclear Career Progression (Effective 1110)

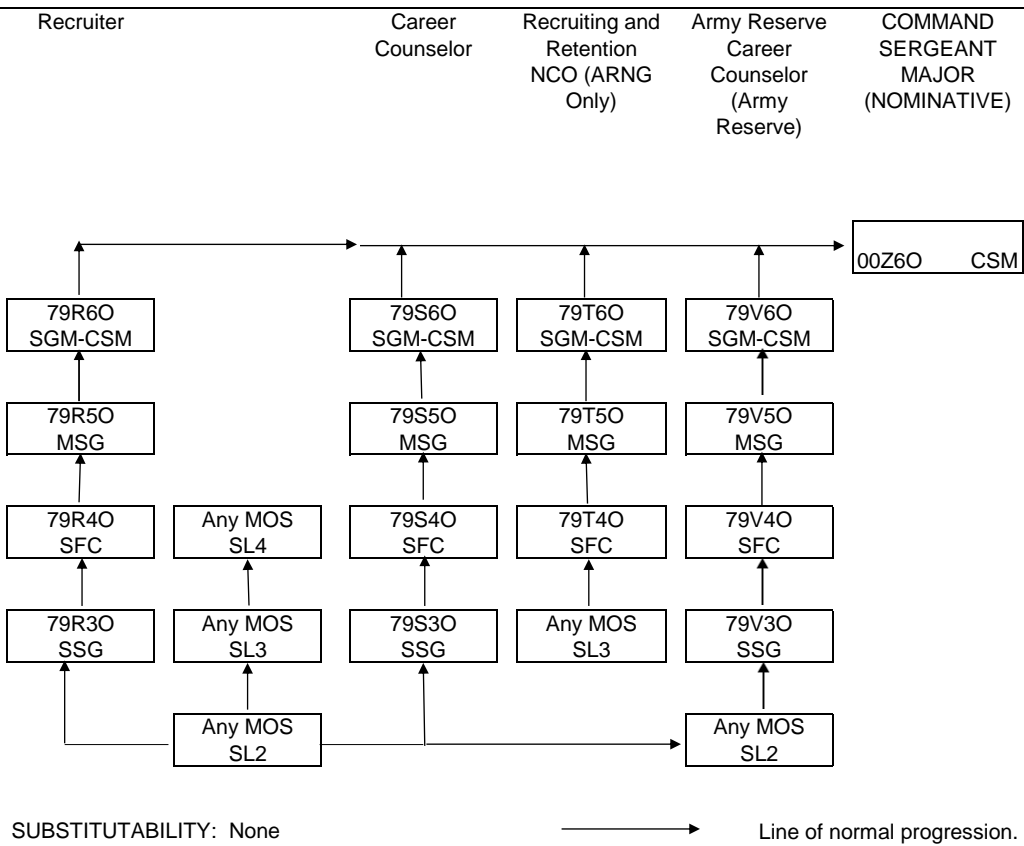
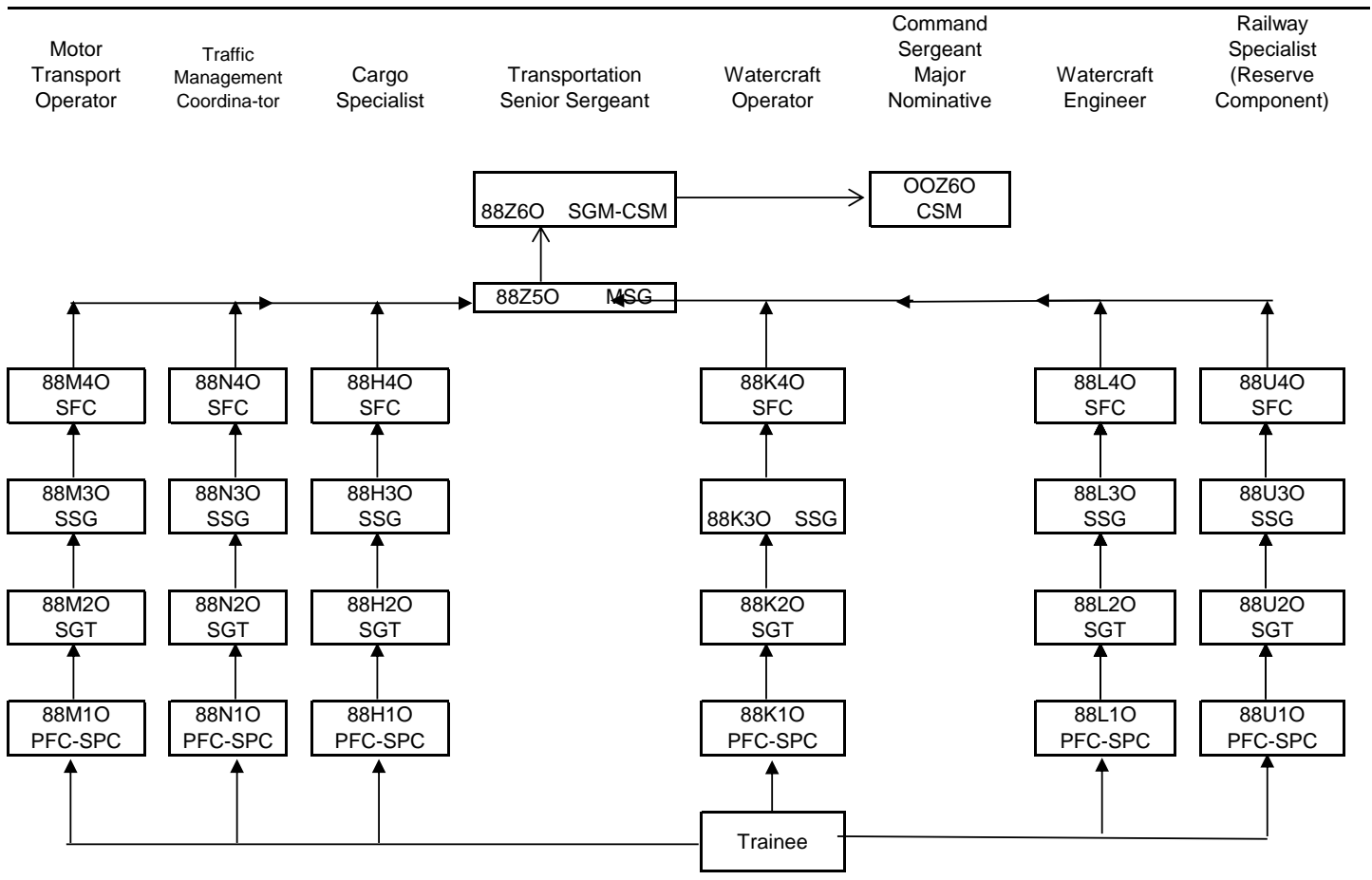

Figure 10-79. CMF 79 - Recruiting and Retention Career Progression (Effective 202309)



SUBSTITUTABILITY: None

—————> Line of normal progression.

Figure 10-88a. CMF 88 - Transportation career progression (Effective 201610)

Explosive Ordnance Disposal Specialist Ammunition Specialist Ammunition Stock Control and Accounting Specialist Command Sergeant Major Nominative

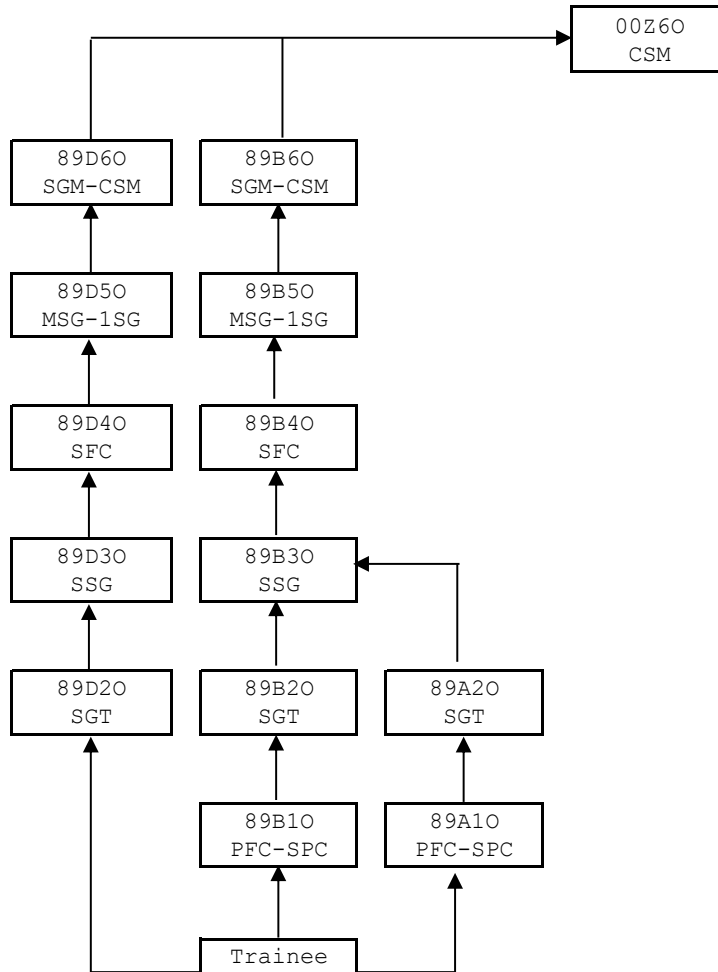

SUBSTITUTABILITY: Between 89A and 89B at skill level 1 and 2 only, if 89B previously performed Ammunition Stock Control and Accounting Specialist duties prior to October 2007.

→ progression.

Figure 10-89. CMF 89 - Ammunition career progression (Effective 202310)

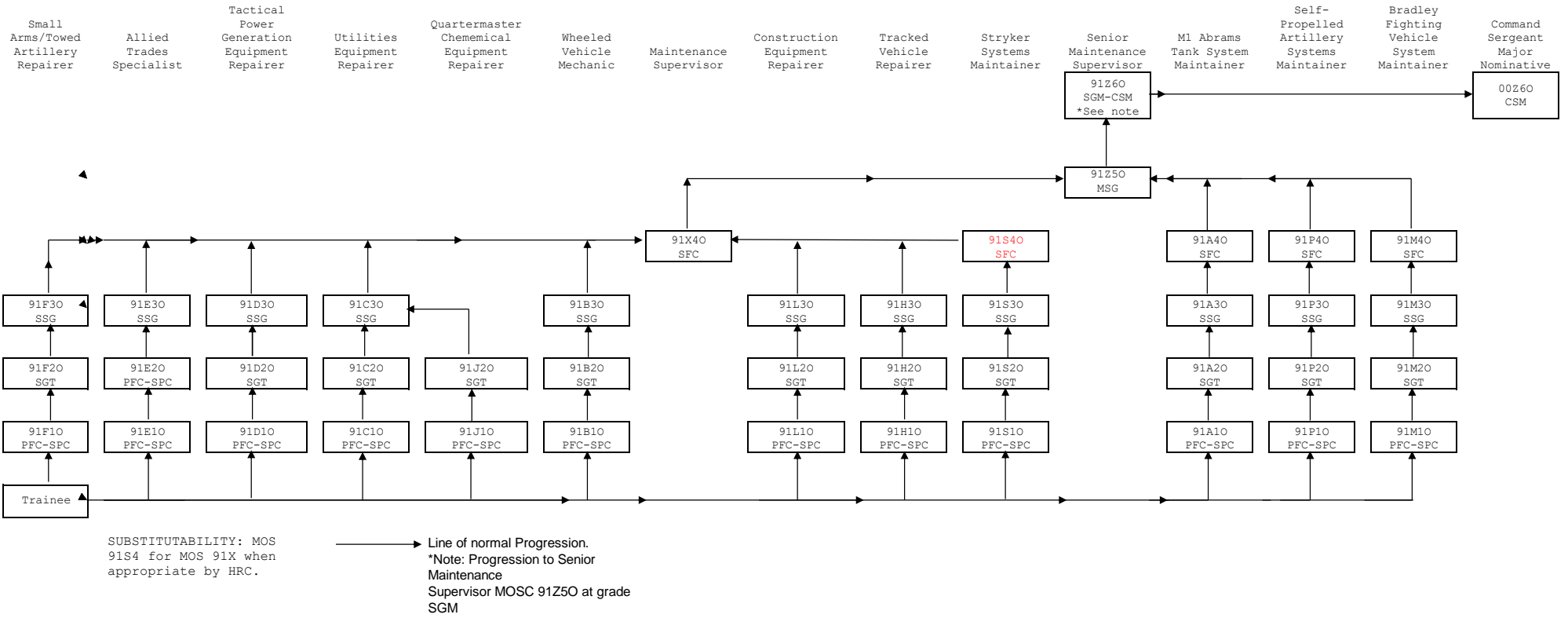

Figure 10-91c. CMF 91--Mechanical Maintenance Career Progression (Effective 201910)

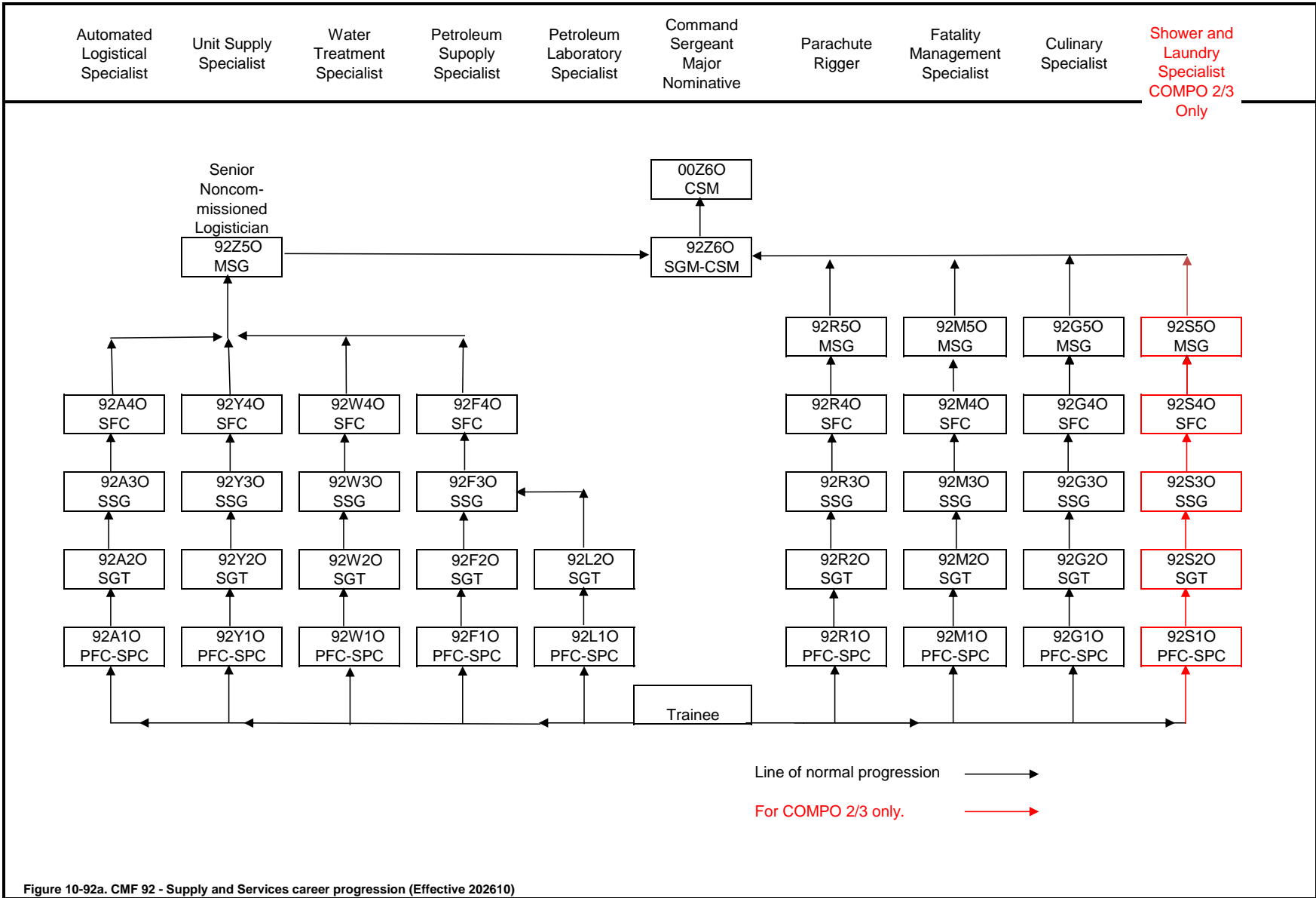

Figure 10-92a. CMF 92 - Supply and Services career progression (Effective 202610)

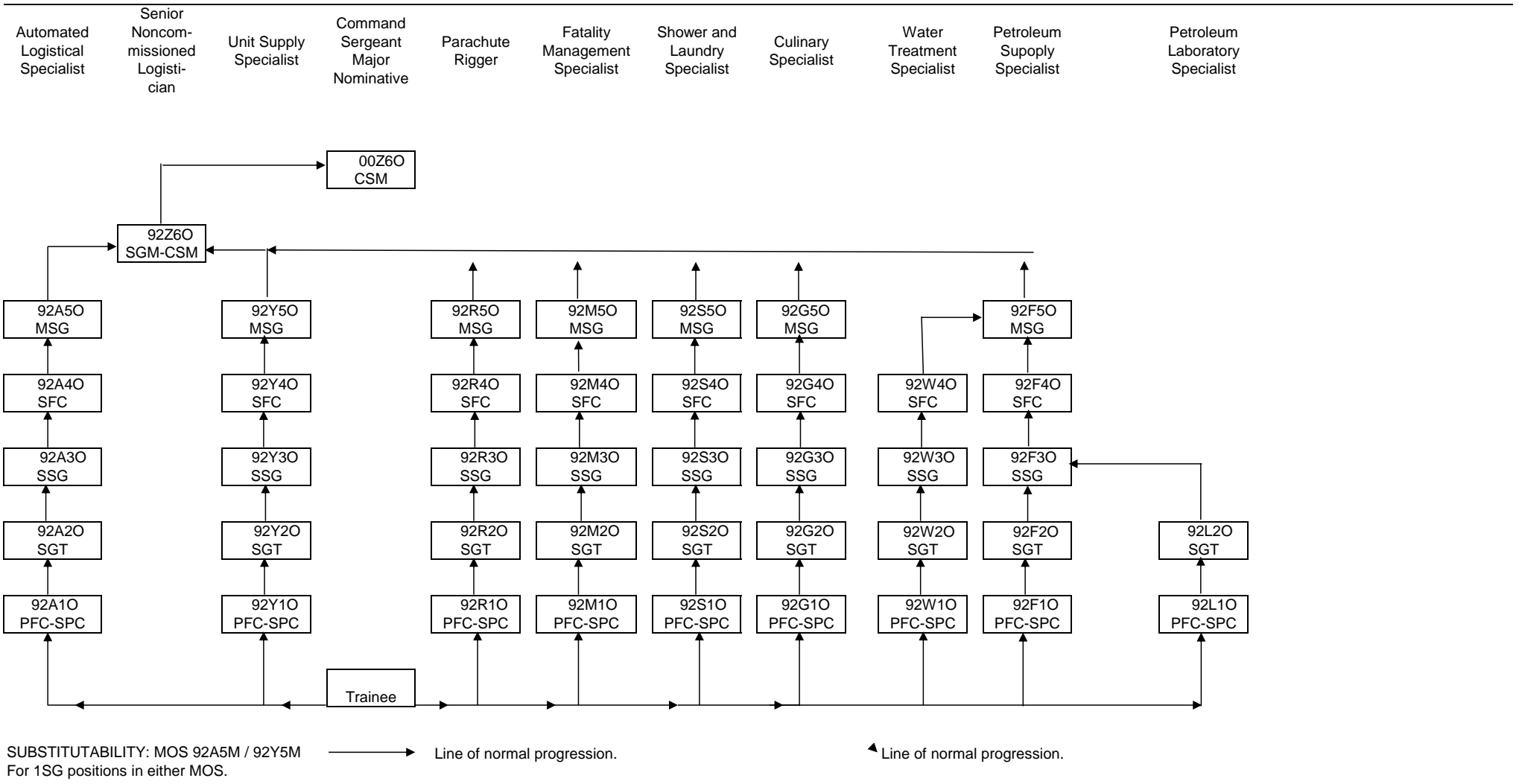

Figure 10-92a. CMF 92 - Supply and Services career progression (Effective 202510)

