

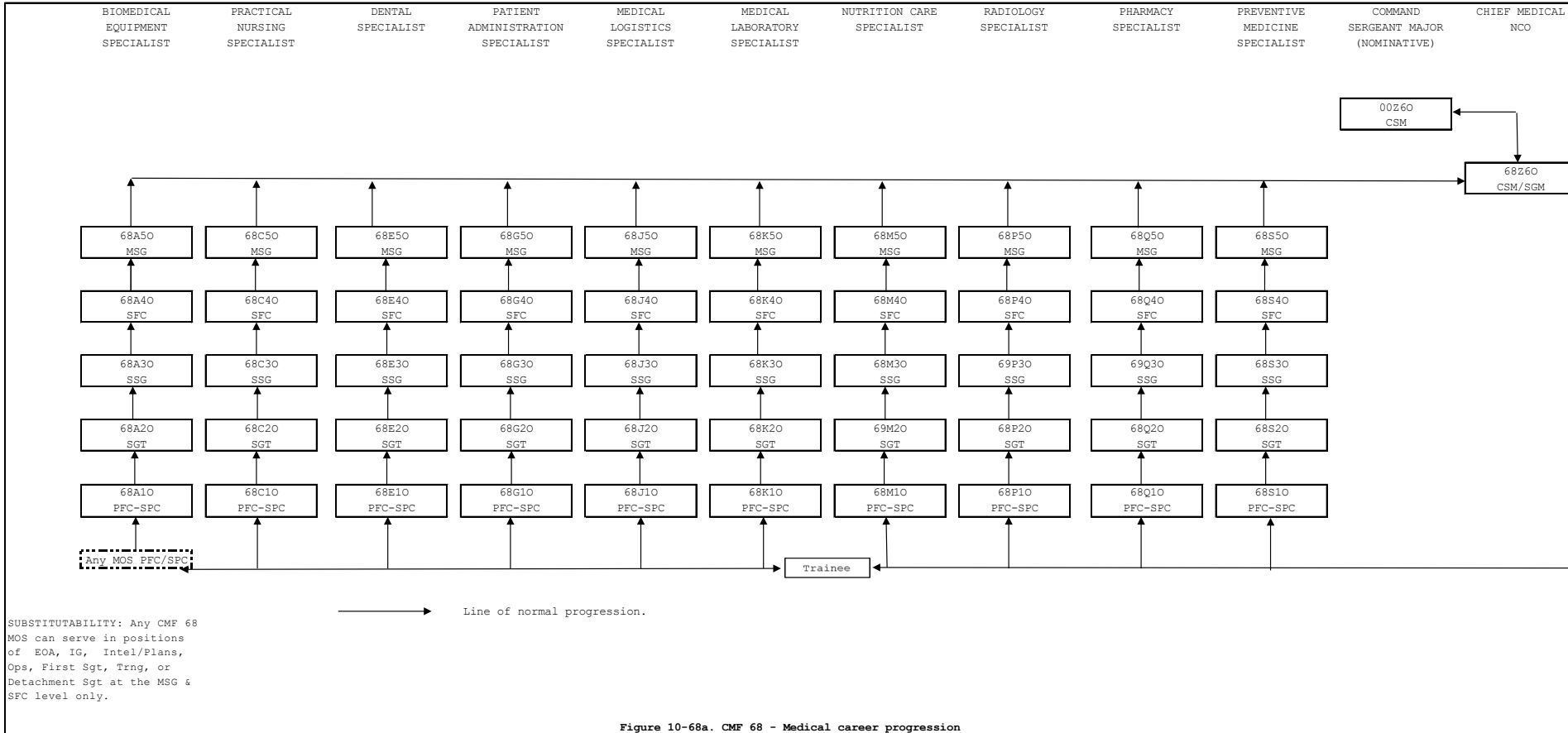

CMF 68 Progression Chart (1 of 2)





CMF 68 Progression Chart (2 of 2)

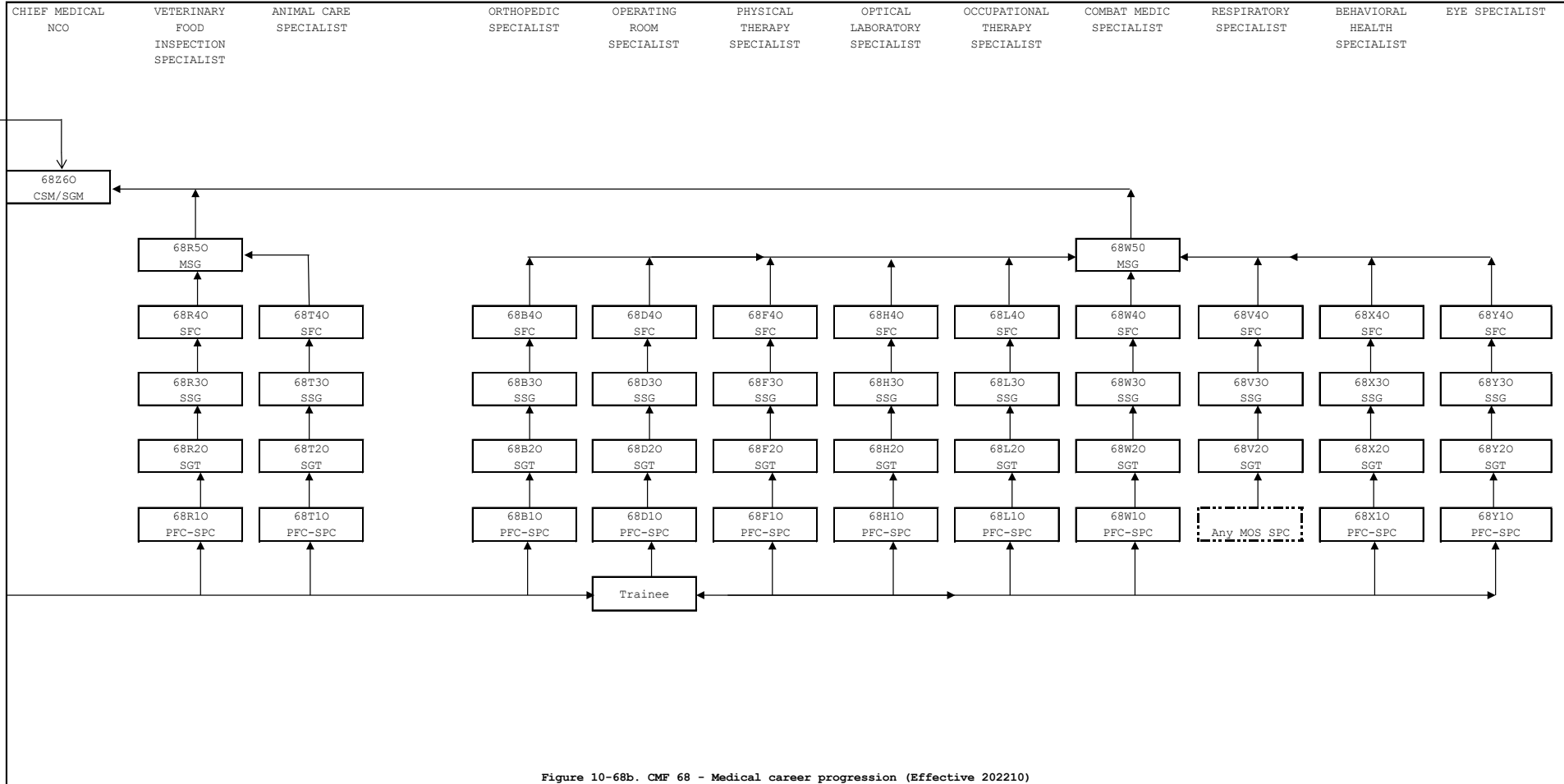



U.S. ARMY

MOS 68A Progression Chart

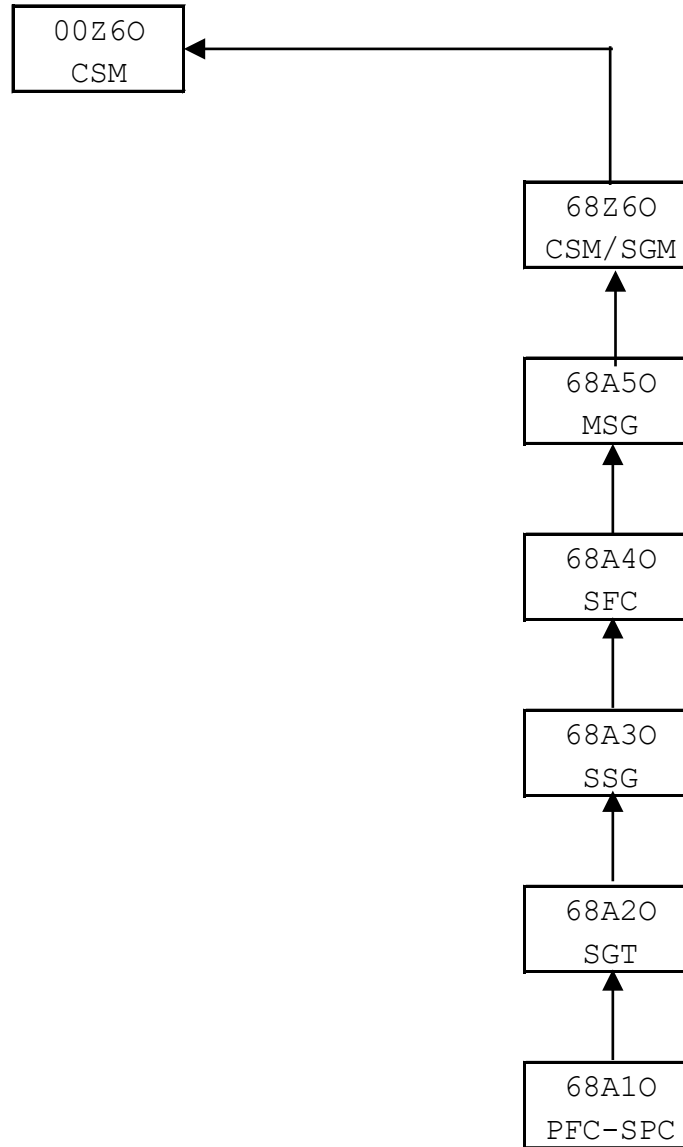



68A Talent Development Model

Years of Service	2	4	6	8	10	12	14	16	18	20	22	24	26	28
Rank														
Key Leadership Position	BIOMEDICAL EQUIP SPEC		MED EQUIP REP BIOMEDICAL EQUIP SGT M1-BIOMEDICAL EQUIP NCO		BIOMEDICAL EQUIP NCO BIOMEDICAL MAINT NCO SFAB NCO		SR BIOMED EQUIP NCO M1-BIOMEDICAL EQUIP NCO MEDICAL MAINT NCO MTTF BIOMED EQUIP OC/T PLATOON SERGEANT INSTRUCTOR SR TRAINING DEV/WRITER			SR BIOMED EQUIP NCO CHIEF INSTRUCTOR FIRST SERGEANT				
Military/Civilian Education	DLC I BLC		DLC II ALC		DLC III SLC		DLC IV MLC			DLC V SMC				
	30 SEMESTER HOURS		ASSOCIATE DEGREE					BACHELOR'S DEGREE						
	CERTIFIED BIOMEDICAL EQUIPMENT TECHNICIAN (CBET), COMPTIA A+, AND COMPTIA NETWORK													
Critical Leadership Development	<div style="border: 1px solid red; padding: 5px; display: inline-block; margin: 5px;">OPERATIONS NCO, NCOIC</div> <div style="border: 1px solid red; padding: 5px; display: inline-block; margin: 5px;">SECTION LEADER / SQUAD LEADER</div> <div style="border: 1px solid red; padding: 5px; display: inline-block; margin: 5px;">DETACHMENT SERGEANT PLATOON SERGEANT</div> <div style="border: 1px solid red; padding: 5px; display: inline-block; margin: 5px;">FIRST SERGEANT</div>													
Broadening Opportunities	<div style="border: 1px solid yellow; padding: 5px; display: inline-block; margin: 5px;">RECRUITER</div> <div style="border: 1px solid yellow; padding: 5px; display: inline-block; margin: 5px;">DRILL SERGEANT</div> <div style="border: 1px solid yellow; padding: 5px; display: inline-block; margin: 5px;">SDS, SDS LEADER, SGL, SSSL, SRU PSG</div> <div style="border: 1px solid yellow; padding: 5px; display: inline-block; margin: 5px;">INSTRUCTOR/WRITER, SFAB, SGL, SOLDIER RECOVERY UNIT (SRU) SQUAD LEADER</div> <div style="border: 1px solid yellow; padding: 5px; display: inline-block; margin: 5px;">ATTACHÉ, EOA, IG NCO, OC/T, SARC, SHARP MASTER ADVOCATE, CHIEF INSTRUCTOR/WRITER, CHIEF TRAINING DEVELOPER/WRITER, MEO INSTRUCTOR, SENIOR INSTRUCTOR/WRITER, SENIOR TRAINING DEVELOPER/WRITER</div>													
Military Training	<div style="border: 1px solid green; padding: 5px; display: inline-block; margin: 5px;">EXPERT FIELD MEDICAL BADGE, AIR ASSAULT, AIRBORNE, RANGER</div> <div style="border: 1px solid green; padding: 5px; display: inline-block; margin: 5px;">MRT, MFT</div> <div style="border: 1px solid green; padding: 5px; display: inline-block; margin: 5px;">EOL, UPL, SUSTAINMENT AUTOMATION SUPPORT MANAGEMENT OFFICE (SASMO)</div> <div style="border: 1px solid green; padding: 5px; display: inline-block; margin: 5px;">BATTLE STAFF, P3T LEADER</div> <div style="border: 1px solid green; padding: 5px; display: inline-block; margin: 5px;">M1-COMPUTED AXIAL TOMOGRAPHY (CAT) SCAN</div>													



MOS 68A

The Biomedical Equipment Specialist performs maintenance services and repairs on all medical equipment, medical systems, medically related equipment, medically related systems, and network medical equipment.

LEADERSHIP POSITIONS

Most-qualified looks like:

SSG: 24 to 48 months as a Squad/Section Leader, M1-Biomedical Equipment NCO, Biomedical Equipment NCO

SFC: 24 to 36 months as a Detachment Sergeant, Platoon Sergeant, Senior Biomedical Equipment NCO

MSG: 18 to 36 months as a Senior Biomedical Equipment NCO, Chief Instructor, First Sergeant

CSM/SGM: N/A

Highly qualified looks like:

SSG: Biomedical Equipment Sergeant

SFC: Biomedical Equipment NCO

MSG: Senior Biomedical Equipment NCO

CSM/SGM: N/A



U.S. ARMY

MOS 68A

PHYSICAL FITNESS

Most-qualified looks like:

SSG: 540 ACFT score or above with 90 points in each event

SFC: 540 ACFT score or above with 90 points in each event

MSG: 540 ACFT score or above with 90 points in each event

CSM/SGM: N/A

Highly qualified looks like:

SSG: 480 ACFT score or above with 80 points in each event

SFC: 480 ACFT score or above with 80 points in each event

MSG: 480 ACFT score or above with 80 points in each event

MILITARY/CIVILIAN EDUCATION

Most-qualified looks like:

SSG: Exceeded ALC Course Standards, Leadership Award, Distinguished Honor/Honor Graduate, AA Degree

SFC: Exceeded SLC Course Standards, Leadership Award, Distinguished Honor/Honor Graduate, BS Degree

MSG: Exceeded MLC Course Standards, Leadership Award, Distinguished Honor/Honor Graduate, MS Degree

Highly qualified looks like:

SSG: Exceeded ALC Course Standards, Commandant's List, >60 college semester hours

SFC: Exceeded SLC Course Standards, Commandant's List, AA Degree

MSG: Exceeded MLC Course Standards, Commandant's List, >90 college semester hours towards BS Degree



MOS 68A

ASSIGNMENTS (Broadening and Critical Leader Development) **PROPONENT SPECIFIC CHALLENGING / HIGH RISK**

SSG: Drill Sergeant, Instructor Writer, Recruiter, Security Forces Assistance Brigade, Small Group Leader, SRU Squad Leader, **NCOIC, Operations NCO, Section/Squad Leader**

SFC: Attaché, Equal Opportunity Advisor, Inspector General NCO, Observer Coach/Trainer, Recruiter, Senior Drill Sergeant, Senior Drill Sergeant Leader, SHARP Master Advocate, SARC, Senior Instructor Writer, Senior Training Developer Writer, Senior Small Group Leader, SRU Platoon Sergeant, **Detachment Sergeant, Operations NCO, NCOIC, Platoon Sergeant**

MSG: Attaché, Chief Instructor Writer, Chief Training Developer Writer, Equal Opportunity Advisor, Inspector General NCO, SHARP Master Advocate, SARC, **First Sergeant**

CSM/SGM: N/A



U.S. ARMY

MOS 68A

TRAINING

Most-qualified looks like:

SSG: EFMB, Certified Biomedical Equipment Technician (CBET), CompTIA A+, CompTIA Network
SFC: EFMB, Certified Biomedical Equipment Technician (CBET), CompTIA A+, CompTIA Network
MSG: EFMB, Certified Biomedical Equipment Technician (CBET), CompTIA A+, CompTIA Network
CSM/SGM: N/A

Highly qualified looks like:

SSG: Air Assault, Airborne, EOL, MFT, MRT, SHARP, P3T Leader
SFC: Air Assault, Airborne, Battle Staff, EOA, MFT, MRT, SHARP, P3T Leader
MSG: Air Assault, Airborne, Battle Staff, EOA, MFT, MRT, SHARP
CSM/SGM: N/A

OTHER INDICATORS

Most-qualified looks like:

SSG: Active Audie Murphy or SGT Morales Club Member, awarded MOVSM for volunteer service, Army Best Medic Competitor, NCO of the Quarter/Year **(all annotated on NCOER)**

SFC: Active Audie Murphy or SGT Morales Club Member, awarded MOVSM for volunteer service, Army Best Medic Competitor, NCO of the Quarter/Year **(all annotated on NCOER)**

MSG: Award of the Order of Military Medical Merit (Regimental Award), Other Regimental Awards **(annotated on NCOER)**

CSM/SGM: N/A



U.S. ARMY

MOS 68B Progression Chart

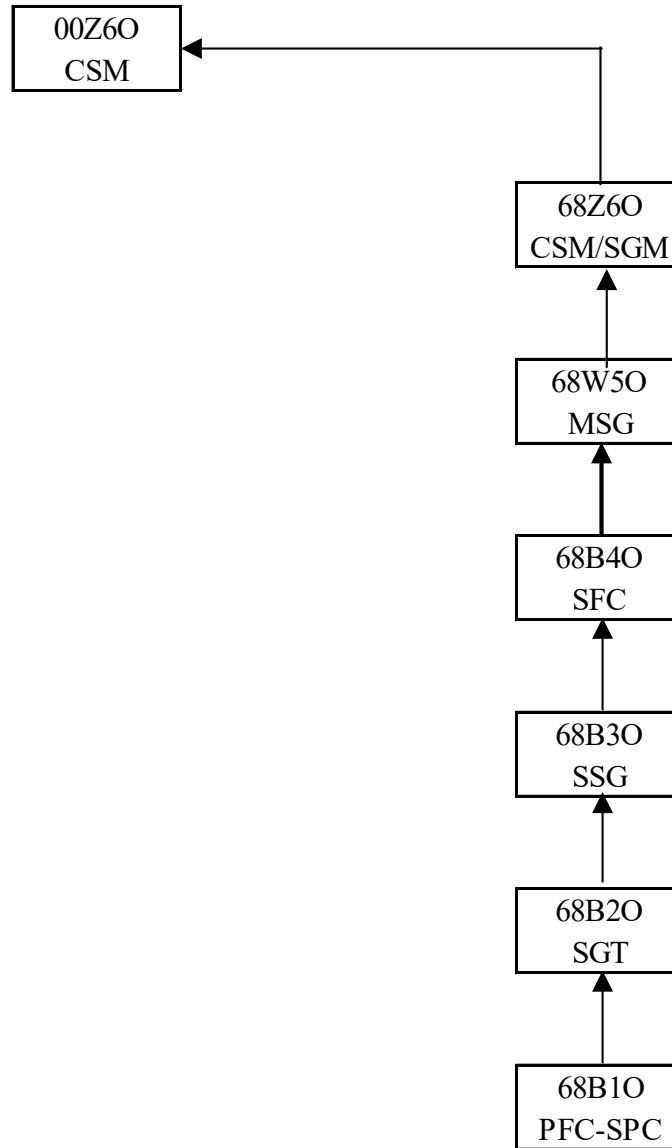



68B Talent Development Model (Merges into 68W at E8/MSG)

Years of Service	2	4	6	8	10	12	14	16	18	20	22	24	26	28		
Rank																
Key Leadership Position	ORTHOPEDIC SPEC		ORTHOPEDIC SGT INSTRUCTOR/WRITER		ORTHOPEDIC SGT INSTRUCTOR		SR ORTHOPEDIC NCO ORTHOPEDIC NCO INSTRUCTOR/WRITER NSTRUCTOR									
Military/Civilian Education	DLC I		DLC II		DLC III		DLC IV		BLC		ALC		SLC		MLC	
	30 SEMESTER HOURS				ASSOCIATE DEGREE											
	ORTHOPEDIC TECHNOLOGIST CERTIFIED (OTC), CERTIFIED ORTHOTIC FITTER (COF), REGISTERED ORTHOPEDIC TECHNOLOGIST (ROT)															
Critical Leadership Development	<div style="border: 1px solid red; padding: 5px; text-align: center; color: red;">OPERATIONS NCO, NCOIC</div> <div style="display: flex; justify-content: space-around; margin-top: 5px;"> <div style="border: 1px solid red; padding: 5px; text-align: center; color: red;">SECTION LEADER / SQUAD LEADER</div> <div style="border: 1px solid red; padding: 5px; text-align: center; color: red;">DETACHMENT SERGEANT PLATOON SERGEANT</div> </div>															
Broadening Opportunities	<div style="background-color: yellow; padding: 5px; text-align: center;">RECRUITER</div> <div style="display: flex; justify-content: space-between; margin-top: 5px;"> <div style="background-color: yellow; padding: 5px; text-align: center;">DRILL SERGEANT</div> <div style="background-color: yellow; padding: 5px; text-align: center;"> SDS, SDS LEADER, SGL, SSGL, SRU PSG, OC/T, ATTACHÉ, EOA, MEO INSTRUCTOR, IG NCO, SARC, SHARP MASTER ADVOCATE, CHIEF INSTRUCTOR/WRITER, CHIEF TRAINING DEVELOPER/WRITER, SENIOR INSTRUCTOR/WRITER, SENIOR TRAINING DEVELOPER/WRITER </div> </div> <div style="background-color: yellow; padding: 5px; text-align: center; margin-top: 5px;"> INSTRUCTOR/WRITER, SGL, SOLDIER RECOVERY UNIT (SRU) SQUAD LEADER </div>															
Military Training	<div style="background-color: lightgreen; padding: 5px; text-align: center;">EXPERT FIELD MEDICAL BADGE, AIR ASSAULT, AIRBORNE, RANGER</div> <div style="background-color: lightgreen; padding: 5px; text-align: center; margin-top: 5px;">EOL, UPL, MRT, MFT</div> <div style="background-color: lightgreen; padding: 5px; text-align: center; margin-top: 5px;">BATTLE STAFF, P3T LEADER</div>															



MOS 68B

The Orthopedic Specialist assists with management of orthopedic clinic, or assists in treatment of patients with orthopedic conditions and injuries, under the supervision of an orthopedic physician, orthopedic physician assistant, or podiatrist.

LEADERSHIP POSITIONS

Most-qualified looks like:

SSG: 24 to 48 months as a Squad Leader, Orthopedic NCO

SFC: 24 to 36 months as a Platoon Sergeant, Detachment Sergeant

MSG: N/A

Highly qualified looks like:

SSG: Orthopedic SGT

SFC: Senior Orthopedic NCO

MSG: N/A



MOS 68B

PHYSICAL FITNESS

Most-qualified looks like:

SSG: 540 ACFT score or above with 90 points in each event

SFC: 540 ACFT score or above with 90 points in each event

MSG: N/A

Highly qualified looks like:

SSG: 480 ACFT score or above with 80 points in each event

SFC: 480 ACFT score or above with 80 points in each event

MSG: N/A

MILITARY/CIVILIAN EDUCATION

Most-qualified looks like:

SSG: Exceeded ALC Course Standards, Leadership Award, Distinguished Honor/Honor Graduate, AA Degree

SFC: Exceeded SLC Course Standards, Leadership Award, Distinguished Honor/Honor Graduate, BS Degree

MSG: N/A

Highly qualified looks like:

SSG: Exceeded ALC Course Standards, Commandant's List, >60 college semester hours

SFC: Exceeded SLC Course Standards, Commandant's List, AA Degree

MSG: N/A



MOS 68B

ASSIGNMENTS (Broadening and Critical Leader Development)
PROPONENT SPECIFIC CHALLENGING / HIGH RISK

SSG: Drill Sergeant, Instructor Writer, Recruiter, Small Group Leader, SRU Squad Leader, NCOIC, Operations NCO, Section/Squad Leader

SFC: Attaché, Equal Opportunity Advisor, Inspector General NCO, Observer Coach/Trainer, Recruiter, Senior Drill Sergeant, Senior Drill Sergeant Leader, SHARP Master Advocate, SARC, Senior Instructor Writer, Senior Training Developer Writer, Senior Small Group Leader, SRU Platoon Sergeant, Detachment Sergeant, Operations NCO, NCOIC, Platoon Sergeant

MSG: N/A



MOS 68B

TRAINING

Most-qualified looks like:

SSG: EFMB, Orthopedic Technologist Certified (OTC), Certified Orthotic Fitter (COF), Registered Orthopedic Technologist (ROT)

SFC: EFMB, Orthopedic Technologist Certified (OTC), Certified Orthotic Fitter (COF), Registered Orthopedic Technologist (ROT)

MSG: N/A

Highly qualified looks like:

SSG: Air Assault, Airborne, EOL, MFT, MRT, SHARP, P3T Leader

SFC: Air Assault, Airborne, Battle Staff, EOA, MFT, MRT, SHARP, P3T Leader

MSG: N/A

OTHER INDICATORS

Most-qualified looks like:

SSG: Active Audie Murphy or SGT Morales Club Member, awarded MOVSM for volunteer service, Army Best Medic Competitor, NCO of the Quarter/Year **(all annotated on NCOER)**

SFC: Active Audie Murphy or SGT Morales Club Member, awarded MOVSM for volunteer service, Army Best Medic Competitor, NCO of the Quarter/Year **(all annotated on NCOER)**

MSG: N/A

MOS 68C Progression Chart



U.S. ARMY

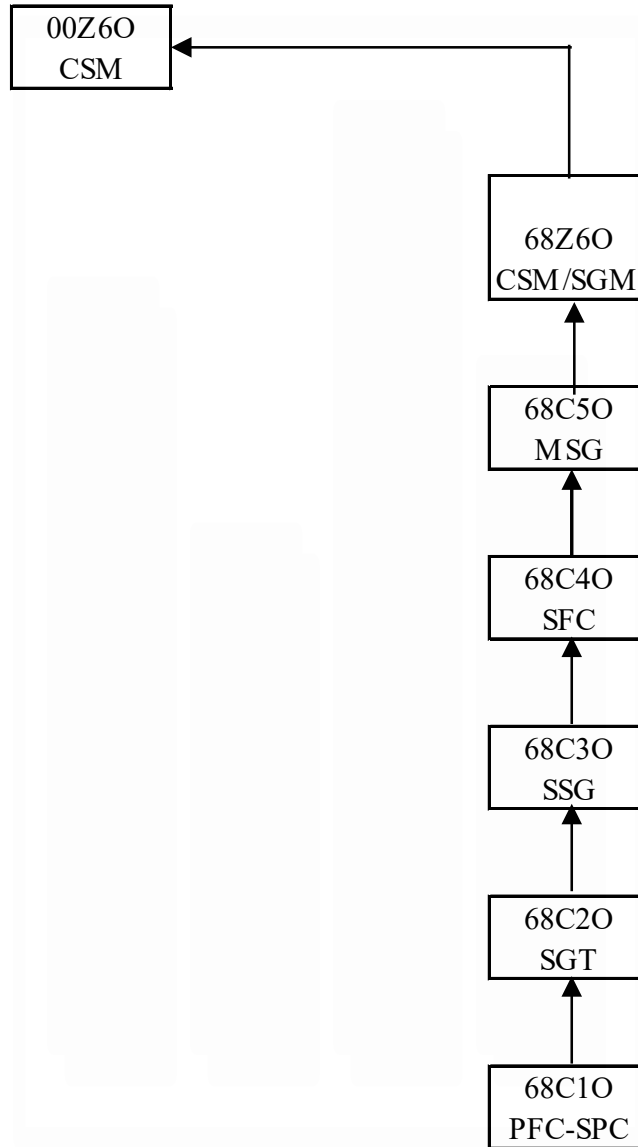



68C Talent Development Model

Years of Service	2	4	6	8	10	12	14	16	18	20	22	24	26	28				
Rank																		
Key Leadership Position	PRACTICAL NURSING SPEC		PRACTICAL NURSE SGT PRACTICAL NURSE NCO PRACTICAL NURSING NCO		PRACTICAL NURSE NCO PRACTICAL NURSE SGT WARDMASTER		PRACTICAL NURSE NCO SR PRACTICAL NURSE NCO WARDMASTER DETACHMENT SERGEANT INSTRUCTOR/WRITER SR TRAINING DEVELOPER/WRITER		SR PRACTICAL NURSE NCO CH INSTRUCTOR/WRITER INSTRUCTOR FIRST SERGEANT									
Military/Civilian Education	DLC I BLC 30 SEMESTER HOURS		DLC II ALC ASSOCIATE DEGREE		DLC III SLC ASSOCIATE DEGREE		DLC IV MLC ASSOCIATE DEGREE		DLC V SMC BACHELOR'S DEGREE		BACHELOR'S DEGREE							
	ADVANCED CARDIAC LIFE SUPPORT (ACLS), PEDIATRIC ADVANCED LIFE SUPPORT (PALS) CERTIFICATIONS																	
Critical Leadership Development					OPERATIONS NCO, NCOIC				SECTION LEADER / SQUAD LEADER		DETACHMENT SERGEANT PLATOON SERGEANT		FIRST SERGEANT					
Broadening Opportunities			RECRUITER				DRILL SERGEANT		SDS, SDS LEADER, SGL, SSSL, SRU PSG		INSTRUCTOR/WRITER, SGL, SOLDIER RECOVERY UNIT (SRU) SQUAD LEADER				ATTACHÉ, EOA, IG NCO, OC/T, SARC, SHARP MASTER ADVOCATE, CHIEF INSTRUCTOR/WRITER, CHIEF TRAINING DEVELOPER/WRITER, MEO INSTRUCTOR, SENIOR INSTRUCTOR/WRITER, SENIOR TRAINING DEVELOPER/WRITER			
Military Training	EXPERT FIELD MEDICAL BADGE, AIR ASSAULT, AIRBORNE, RANGER																	
					EOL, UPL, MRT, MFT				BATTLE STAFF, P3T LEADER									



MOS 68C

The Practical Nursing Specialist supervises or performs preventive, therapeutic, and emergency nursing care procedures under supervision of a physician, or nurse.

LEADERSHIP POSITIONS

Most-qualified looks like:

SSG: 24 to 48 months as a Squad Leader, Section Sergeant, NCOIC,

SFC: 24 to 36 months as a Detachment Sergeant, Platoon Sergeant, Senior Practical Nurse NCO

MSG: 18 to 36 months as a First Sergeant

CSM/SGM: N/A

Highly qualified looks like:

SSG: Practical Nurse SGT

SFC: Wardmaster

MSG: Senior Practical Nurse NCO

CSM/SGM: N/A



MOS 68C

PHYSICAL FITNESS

Most-qualified looks like:

SSG: 540 ACFT score or above with 90 points in each event
SFC: 540 ACFT score or above with 90 points in each event
MSG: 540 ACFT score or above with 90 points in each event
CSM/SGM: N/A

Highly qualified looks like:

SSG: 480 ACFT score or above with 80 points in each event
SFC: 480 ACFT score or above with 80 points in each event
MSG: 480 ACFT score or above with 80 points in each event

MILITARY/CIVILIAN EDUCATION

Most-qualified looks like:

SSG: Exceeded ALC Course Standards, Leadership Award, Distinguished Honor/Honor Graduate, AA Degree
SFC: Exceeded SLC Course Standards, Leadership Award, Distinguished Honor/Honor Graduate, BS Degree
MSG: Exceeded MLC Course Standards, Leadership Award, Distinguished Honor/Honor Graduate, MS Degree

Highly qualified looks like:

SSG: Exceeded ALC Course Standards, Commandant's List, >60 college semester hours
SFC: Exceeded SLC Course Standards, Commandant's List, AA Degree
MSG: Exceeded MLC Course Standards, Commandant's List, >90 college semester hours towards BS Degree



MOS 68C

ASSIGNMENTS (Broadening and Critical Leader Development) **PROPONENT SPECIFIC CHALLENGING / HIGH RISK**

SSG: Drill Sergeant, Instructor Writer, Recruiter, Small Group Leader, SRU Squad Leader, **NCOIC, Operations NCO, Section/Squad Leader**

SFC: Attaché, Equal Opportunity Advisor, Inspector General NCO, Observer Coach/Trainer, Recruiter, Senior Drill Sergeant, Senior Drill Sergeant Leader, SHARP Master Advocate, SARC, Senior Instructor Writer, Senior Training Developer Writer, Senior Small Group Leader, SRU Platoon Sergeant, **Detachment Sergeant, Operations NCO, NCOIC, Platoon Sergeant**

MSG: Attaché, Chief Instructor Writer, Chief Training Developer Writer, Equal Opportunity Advisor, Inspector General NCO, SHARP Master Advocate, SARC, **First Sergeant**

CSM/SGM: N/A



MOS 68C

TRAINING

Most-qualified looks like:

SSG: EFMB, Advanced Cardiac Life Support, Pediatric Advanced Life Support Certifications

SFC: EFMB, Advanced Cardiac Life Support, Pediatric Advanced Life Support Certifications

MSG: EFMB, Advanced Cardiac Life Support, Pediatric Advanced Life Support Certifications

CSM/SGM: N/A

Highly qualified looks like:

SSG: Air Assault, Airborne, EOL, MFT, MRT, SHARP, P3T Leader

SFC: Air Assault, Airborne, Battle Staff, EOA, MFT, MRT, SHARP, P3T Leader

MSG: Air Assault, Airborne, Battle Staff, EOA, MFT, MRT, SHARP

CSM/SGM: N/A

OTHER INDICATORS

Most-qualified looks like:

SSG: Active Audie Murphy or SGT Morales Club Member, awarded MOVSM for volunteer service, Army Best Medic Competitor, NCO of the Quarter/Year (**all annotated on NCOER**)

SFC: Active Audie Murphy or SGT Morales Club Member, awarded MOVSM for volunteer service, Army Best Medic Competitor, NCO of the Quarter/Year (**all annotated on NCOER**)

MSG: Award of the Order of Military Medical Merit (Regimental Award), Other Regimental Awards (**annotated on NCOER**)



MOS 68C

FULLY-QUALIFIED (MANDATORY)

Established requirements from Federal/ DoD/Legislative Authorities

SSG: Licensed Practical Nurse Certification, National Council of State Boards of Nursing (NCSBN)

SFC: Licensed Practical Nurse Certification, National Council of State Boards of Nursing (NCSBN)

MSG: Licensed Practical Nurse Certification, National Council of State Boards of Nursing (NCSBN)

CSM/SGM: N/A



U.S. ARMY

MOS 68D Progression Chart

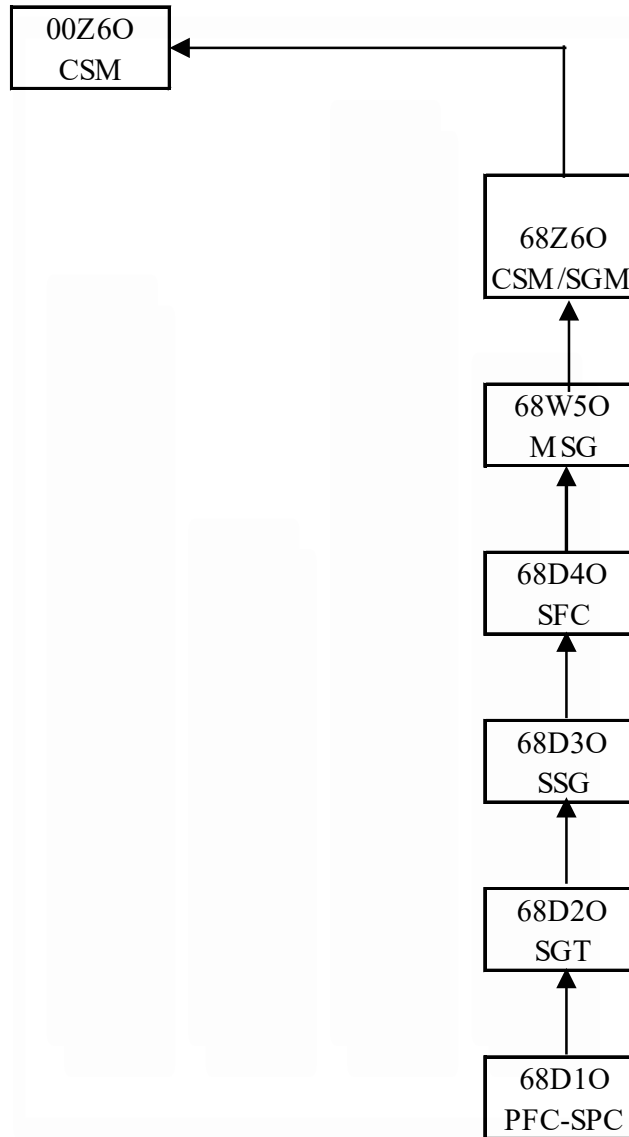



68D Talent Development Model (Merges into 68W at E8/MSG)

Years of Service	2	4	6	8	10	12	14	16	18	20	22	24	26	28
Rank														
Key Leadership Position	OPERATING ROOM SPEC		OPERATING ROOM SGT OPERATING ROOM NCO		OPERATING ROOM NCO SQUAD LEADER INSTRUCTOR/WRITER		SR OPERATING ROOM NCO OPERATIONS NCO SR TRAINING DEVELOPER INSTRUCTOR/WRITER MTTF CLINICAL OC/T							
Military/Civilian Education	DLC I		DLC II		DLC III		DLC IV							
	BLC		ALC		SLC		MLC							
	30 SEMESTER HOURS			ASSOCIATE DEGREE										
	CERTIFIED STERILE PROCESSING & DISTRIBUTION TECHNICIAN (CSPDT), CERTIFIED SURGICAL TECHNOLOGIST (CST)													
Critical Leadership Development	<div style="border: 1px solid red; padding: 5px; text-align: center;">OPERATIONS NCO, NCOIC</div> <div style="display: flex; justify-content: space-around; margin-top: 5px;"> <div style="border: 1px solid red; padding: 5px; text-align: center;">SECTION LEADER / SQUAD LEADER</div> <div style="border: 1px solid red; padding: 5px; text-align: center;">DETACHMENT SERGEANT PLATOON SERGEANT</div> </div>													
Broadening Opportunities	<div style="border: 1px solid yellow; padding: 5px; text-align: center;">RECRUITER</div> <div style="display: flex; justify-content: space-between; margin-top: 5px;"> <div style="border: 1px solid yellow; padding: 5px; text-align: center;">DRILL SERGEANT</div> <div style="border: 1px solid yellow; padding: 5px; text-align: center;"> SDS, SDS LEADER, SGL, SSGL, SRU PSG, OC/T, ATTACHÉ, EOA, MEO INSTRUCTOR, IG NCO, SARC, SHARP MASTER ADVOCATE, CHIEF INSTRUCTOR/WRITER, CHIEF TRAINING DEVELOPER/WRITER, SENIOR INSTRUCTOR/WRITER, SENIOR TRAINING DEVELOPER/WRITER </div> </div> <div style="border: 1px solid yellow; padding: 5px; text-align: center; margin-top: 5px;"> INSTRUCTOR/WRITER, SGL, SOLDIER RECOVERY UNIT (SRU) SQUAD LEADER </div>													
Military Training	<div style="border: 1px solid green; padding: 5px; text-align: center;">EXPERT FIELD MEDICAL BADGE, AIR ASSAULT, AIRBORNE, RANGER</div> <div style="border: 1px solid green; padding: 5px; text-align: center; margin-top: 5px;">EOL, UPL, MRT, MFT</div> <div style="border: 1px solid green; padding: 5px; text-align: center; margin-top: 5px;">BATTLE STAFF, P3T LEADER</div>													



MOS 68D

The operating room specialist assists the nursing staff in preparing the patient and the operating room (OR) environment for surgery and for providing assistance to the medical staff during surgical procedures. They also operate the centralized material service (CMS) and are responsible for preparing and maintaining sterile medical supplies and special equipment for medical treatment facilities. The operating room specialist also assists in the management of operating room suites.

LEADERSHIP POSITIONS

Most-qualified looks like:

SSG: 24 to 48 months as a Squad Leader, Section Sergeant, NCOIC, Operating Room NCO

SFC: 24 to 36 months as a Detachment Sergeant, Platoon Sergeant,

MSG: N/A

Highly qualified looks like:

SSG: Operating Room NCO

SFC: Senior Operating Room NCO

MSG: N/A



U.S. ARMY

MOS 68D

PHYSICAL FITNESS

Most-qualified looks like:

SSG: 540 ACFT score or above with 90 points in each event

SFC: 540 ACFT score or above with 90 points in each event

MSG: N/A

Highly qualified looks like:

SSG: 480 ACFT score or above with 80 points in each event

SFC: 480 ACFT score or above with 80 points in each event

MSG: N/A

MILITARY/CIVILIAN EDUCATION

Most-qualified looks like:

SSG: Exceeded ALC Course Standards, Leadership Award, Distinguished Honor/Honor Graduate, AA Degree

SFC: Exceeded SLC Course Standards, Leadership Award, Distinguished Honor/Honor Graduate, BS Degree

MSG: N/A

Highly qualified looks like:

SSG: Exceeded ALC Course Standards, Commandant's List, >60 college semester hours

SFC: Exceeded SLC Course Standards, Commandant's List, AA Degree

MSG: N/A



MOS 68D

ASSIGNMENTS (Broadening and Critical Leader Development)
PROPONENT SPECIFIC CHALLENGING / HIGH RISK

SSG: Drill Sergeant, Instructor Writer, Recruiter, Small Group Leader, SRU Squad Leader, NCOIC, Operations NCO, Section/Squad Leader

SFC: Attaché, Equal Opportunity Advisor, Inspector General NCO, Observer Coach/Trainer, Recruiter, Senior Drill Sergeant, Senior Drill Sergeant Leader, SHARP Master Advocate, SARC, Senior Instructor Writer, Senior Training Developer Writer, Senior Small Group Leader, SRU Platoon Sergeant, Detachment Sergeant, Operations NCO, NCOIC, Platoon Sergeant

MSG: N/A



MOS 68D

TRAINING

Most-qualified looks like:

SSG: Certified Sterile Processing & Distribution Technician (CSPDT), Certified Surgical Technologist (CST)

SFC: Certified Sterile Processing & Distribution Technician (CSPDT), Certified Surgical Technologist (CST)

MSG: N/A

Highly qualified looks like:

SSG: Air Assault, Airborne, EOL, MFT, MRT, SHARP, P3T Leader

SFC: Air Assault, Airborne, Battle Staff, EOA, MFT, MRT, SHARP, P3T Leader

MSG: N/A

OTHER INDICATORS

Most-qualified looks like:

SSG: Active Audie Murphy or SGT Morales Club Member, awarded MOVSM for volunteer service, Army Best Medic Competitor, NCO of the Quarter/Year (**all annotated on NCOER**)

SFC: Active Audie Murphy or SGT Morales Club Member, awarded MOVSM for volunteer service, Army Best Medic Competitor, NCO of the Quarter/Year (**all annotated on NCOER**)

MSG: N/A



U.S. ARMY

MOS 68E Progression Chart

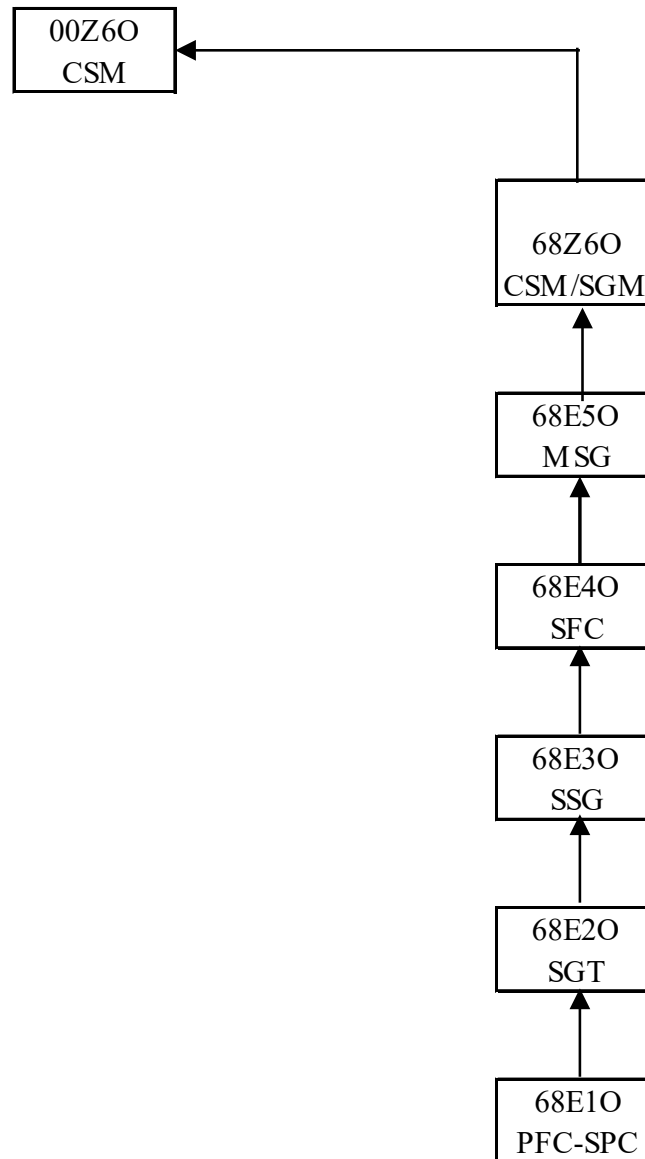



68E Talent Development Model

Years of Service

2 4 6 8 10 12 14 16 18 20 22 24 26 28

Rank												
Key Leadership Position	DENTAL SPEC N5-DENTAL LABORATORY SPEC X2-PREV DENTISTRY SPEC		DENTAL SGT N5-DENTAL LAB SGT X2-PREV DENTISTRY SGT		SR DENTAL NCO SR DENTAL LAB NCO DRILL SERGEANT INSTRUCTOR RECRUITER SGL		DENTAL NCO PLATOON SERGEANT OPS SERGEANT SR TRAINING DEV/WRITER INSTRUCTOR SGL		SR DENTAL NCO CHIEF INSTRUCTOR FIRST SERGEANT			
Military/Civilian Education	DLC I BLC 30 SEMESTER HOURS		DLC II ALC ASSOCIATE DEGREE		DLC III SLC ASSOCIATE DEGREE		DLC IV MLC ASSOCIATE DEGREE		DLC V SMC BACHELOR'S DEGREE		BACHELOR'S DEGREE	
	DENTAL ASSISTING NATIONAL BOARD (DANB), CERTIFIED DENTAL ASSISTANT (CDA)											
Critical Leadership Development	<div style="border: 1px solid red; padding: 5px; display: inline-block; margin: 5px;">OPERATIONS NCO, NCOIC</div> <div style="border: 1px solid red; padding: 5px; display: inline-block; margin: 5px;">SECTION LEADER / SQUAD LEADER</div> <div style="border: 1px solid red; padding: 5px; display: inline-block; margin: 5px;">DETACHMENT SERGEANT PLATOON SERGEANT</div> <div style="border: 1px solid red; padding: 5px; display: inline-block; margin: 5px;">FIRST SERGEANT</div>											
Broadening Opportunities	<div style="border: 1px solid yellow; padding: 5px; display: inline-block; margin: 5px;">RECRUITER</div> <div style="border: 1px solid yellow; padding: 5px; display: inline-block; margin: 5px;">DRILL SERGEANT</div> <div style="border: 1px solid yellow; padding: 5px; display: inline-block; margin: 5px;">SDS, SDS LEADER, SGL, SSGL, SRU PSG</div> <div style="border: 1px solid yellow; padding: 5px; display: inline-block; margin: 5px;">INSTRUCTOR/WRITER, SGL, SOLDIER RECOVERY UNIT (SRU) SQUAD LEADER</div> <div style="border: 1px solid yellow; padding: 5px; display: inline-block; margin: 5px;">ATTACHÉ, EOA, IG NCO, OC/T, SARC, SHARP MASTER ADVOCATE, CHIEF INSTRUCTOR/WRITER, CHIEF TRAINING DEVELOPER/WRITER, MEO INSTRUCTOR, SENIOR INSTRUCTOR/WRITER, SENIOR TRAINING DEVELOPER/WRITER</div>											
Military Training	<div style="border: 1px solid green; padding: 5px; display: inline-block; margin: 5px;">EXPERT FIELD MEDICAL BADGE, AIR ASSAULT, AIRBORNE, RANGER</div> <div style="border: 1px solid green; padding: 5px; display: inline-block; margin: 5px;">X2-PREVENTIVE DENTISTRY</div> <div style="border: 1px solid green; padding: 5px; display: inline-block; margin: 5px;">BATTLE STAFF, P3T LEADER</div> <div style="border: 1px solid green; padding: 5px; display: inline-block; margin: 5px;">EOL, UPL, MRT, MFT</div> <div style="border: 1px solid green; padding: 5px; display: inline-block; margin: 5px;">N5-DENTAL LABORATORY</div>											



MOS 68E

The Dental Specialist assists the dental officer in prevention, examination, and treatment of diseases of teeth and oral region, or assists with the management of dental treatment facilities.

LEADERSHIP POSITIONS

Most-qualified looks like:

SSG: 24 to 48 months as a Squad Leader, Section Sergeant, NCOIC, Dental NCO

SFC: 24 to 36 months as a Detachment Sergeant, Platoon Sergeant, Senior Dental NCO

MSG: 18 to 36 months as a First Sergeant

CSM/SGM: N/A

Highly qualified looks like:

SSG: Dental Sergeant

SFC: Senior Dental NCO

MSG: Chief Dental NCO

CSM/SGM: N/A



MOS 68E

PHYSICAL FITNESS

Most-qualified looks like:

SSG: 540 ACFT score or above with 90 points in each event

SFC: 540 ACFT score or above with 90 points in each event

MSG: 540 ACFT score or above with 90 points in each event

CSM/SGM: N/A

Highly qualified looks like:

SSG: 480 ACFT score or above with 80 points in each event

SFC: 480 ACFT score or above with 80 points in each event

MSG: 480 ACFT score or above with 80 points in each event

MILITARY/CIVILIAN EDUCATION

Most-qualified looks like:

SSG: Exceeded ALC Course Standards, Leadership Award, Distinguished Honor/Honor Graduate, AA Degree

SFC: Exceeded SLC Course Standards, Leadership Award, Distinguished Honor/Honor Graduate, BS Degree

MSG: Exceeded MLC Course Standards, Leadership Award, Distinguished Honor/Honor Graduate, MS Degree

Highly qualified looks like:

SSG: Exceeded ALC Course Standards, Commandant's List, >60 college semester hours

SFC: Exceeded SLC Course Standards, Commandant's List, AA Degree

MSG: Exceeded MLC Course Standards, Commandant's List, >90 college semester hours towards BS Degree



MOS 68E

ASSIGNMENTS (Broadening and Critical Leader Development) PROPONENT SPECIFIC CHALLENGING / HIGH RISK

SSG: Drill Sergeant, Instructor Writer, Recruiter, Small Group Leader, SRU Squad Leader, NCOIC, Operations NCO, Section/Squad Leader

SFC: Attaché, Equal Opportunity Advisor, Inspector General NCO, Observer Coach/Trainer, Recruiter, Senior Drill Sergeant, Senior Drill Sergeant Leader, SHARP Master Advocate, SARC, Senior Instructor Writer, Senior Training Developer Writer, Senior Small Group Leader, SRU Platoon Sergeant, Detachment Sergeant, Operations NCO, NCOIC, Platoon Sergeant

MSG: Attaché, Chief Instructor Writer, Chief Training Developer Writer, Equal Opportunity Advisor, Inspector General NCO, SHARP Master Advocate, SARC, First Sergeant

CSM/SGM: N/A



U.S. ARMY

MOS 68E

TRAINING

Most-qualified looks like:

SSG: EFMB, Registered Dental Assistant (RDA)

SFC: EFMB, Registered Dental Assistant (RDA)

MSG: EFMB, Registered Dental Assistant (RDA)

CSM/SGM: N/A

Highly qualified looks like:

SSG: Air Assault, Airborne, EOL, MFT, MRT, SHARP, P3T Leader

SFC: Air Assault, Airborne, Battle Staff, EOA, MFT, MRT, SHARP, P3T Leader

MSG: Air Assault, Airborne, Battle Staff, EOA, MFT, MRT, SHARP

OTHER INDICATORS

Most-qualified looks like:

SSG: Active Audie Murphy or SGT Morales Club Member, awarded MOVSM for volunteer service, Army Best Medic Competitor, NCO of the Quarter/Year (**all annotated on NCOER**)

SFC: Active Audie Murphy or SGT Morales Club Member, awarded MOVSM for volunteer service, Army Best Medic Competitor, NCO of the Quarter/Year (**all annotated on NCOER**)

MSG: Award of the Order of Military Medical Merit (Regimental Award), Other Regimental Awards (**annotated on NCOER**)



U.S. ARMY

MOS 68F Progression Chart

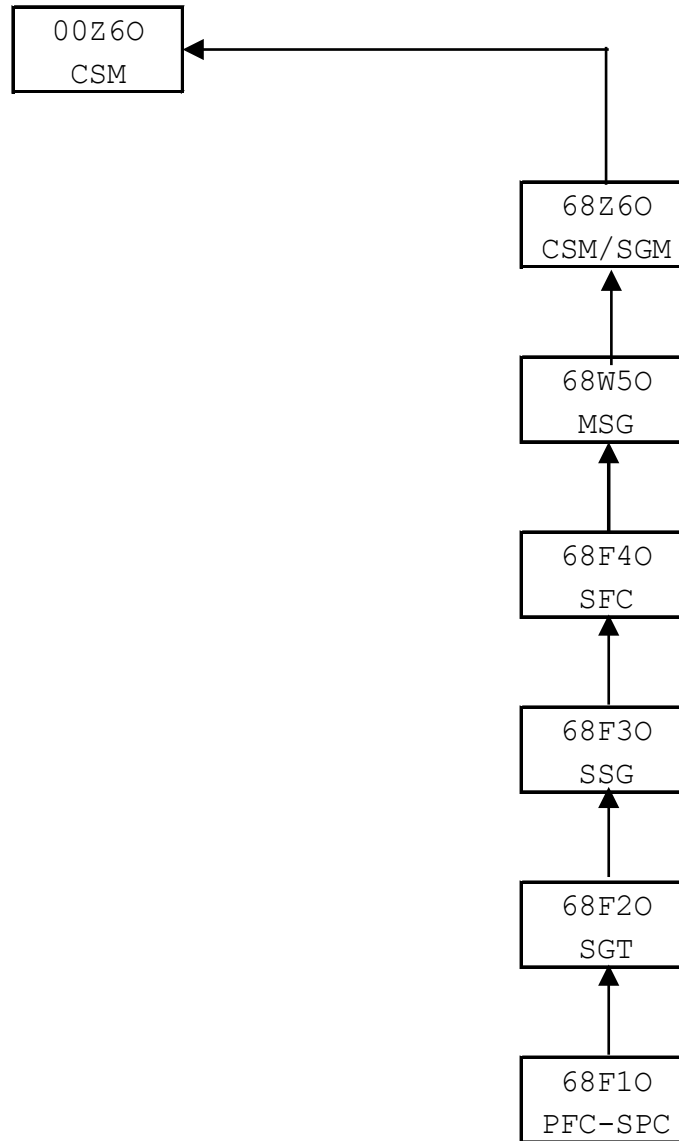



68F Talent Development Model (Merges into 68W at E8/MSG)

Years of Service	2	4	6	8	10	12	14	16	18	20	22	24	26	28
Rank														
Key Leadership Position	PHYSICAL THERAPY SPEC PT SPEC H2F SPEC		PHYSICAL THERAPY SGT PHYSICAL THERAPY SPEC H2F NCO SFAB NCO		PHYSICAL THERAPY NCO INSTRUCTOR/WRITER INSTRUCTOR H2F NCO		PHYSICAL THERAPY NCO PT NCO QUALITY ASSURANCE INSTRUCTOR/WRITER INSTRUCTOR							
Military/Civilian Education	DLC I		DLC II		DLC III		DLC IV							
	BLC		ALC		SLC		MLC							
	30 SEMESTER HOURS		ASSOCIATE DEGREE											
	NATIONAL PHYSICAL THERAPIST ASSISTANT EXAM (NPAT), NATIONAL STRENGTH & CONDITIONING ASSOCIATION, CERTIFIED PERSONAL TRAINER (NSCA-CPT)													
Critical Leadership Development	OPERATIONS NCO, NCOIC													
	SECTION LEADER / SQUAD LEADER													
	DETACHMENT SERGEANT PLATOON SERGEANT													
Broadening Opportunities	RECRUITER													
	DRILL SERGEANT, H2F						SDS, SDS LEADER, SGL, SSGL, SRU PSG, OC/T,							
	INSTRUCTOR/WRITER, SFAB, SGL, SOLDIER RECOVERY UNIT (SRU) SQUAD LEADER						ATTACHÉ, EOA, MEO INSTRUCTOR, IG NCO, SARC, SHARP MASTER ADVOCATE, CHIEF INSTRUCTOR/WRITER, CHIEF TRAINING DEVELOPER/WRITER, SENIOR INSTRUCTOR/WRITER, SENIOR TRAINING DEVELOPER/WRITER							
Military Training	EXPERT FIELD MEDICAL BADGE, AIR ASSAULT, AIRBORNE, RANGER													
	EOL, UPL, MRT, MFT													
	BATTLE STAFF, P3T LEADER													



MOS 68F

The Physical Therapy Specialist, under the direction of a physical therapist and following medical referral, supervises or administers physical therapy to decrease physical disabilities and promotes physical fitness of patients.

LEADERSHIP POSITIONS

Most-qualified looks like:

SSG: 24 to 36 months as months as a Squad Leader, Section Sergeant, NCOIC, Physical Therapy NCO

SFC: 24 to 36 months as months as a Platoon Sergeant, Detachment Sergeant

MSG: N/A

Highly qualified looks like:

SSG: Physical Therapy SGT

SFC: Senior Physical Therapy NCO

MSG: N/A



MOS 68F

PHYSICAL FITNESS

Most-qualified looks like:

SSG: 540 ACFT score or above with 90 points in each event

SFC: 540 ACFT score or above with 90 points in each event

MSG: N/A

Highly qualified looks like:

SSG: 480 ACFT score or above with 80 points in each event

SFC: 480 ACFT score or above with 80 points in each event

MSG: N/A

MILITARY/CIVILIAN EDUCATION

Best-qualified looks like:

SSG: Exceeded ALC Course Standards, Leadership Award, Distinguished Honor/Honor Graduate, AA Degree

SFC: Exceeded SLC Course Standards, Leadership Award, Distinguished Honor/Honor Graduate, BS Degree

MSG: N/A

Highly qualified looks like:

SSG: Exceeded ALC Course Standards, Commandant's List, >60 college semester hours

SFC: Exceeded SLC Course Standards, Commandant's List, AA Degree

MSG: N/A



MOS 68F

ASSIGNMENTS (Broadening and Critical Leader Development)
PROPONENT SPECIFIC CHALLENGING / HIGH RISK

SSG: Drill Sergeant, Holistic Health and Fitness NCO, Instructor Writer, Recruiter, Small Group Leader, SRU Squad Leader, NCOIC, Operations NCO, Section/Squad Leader

SFC: Attaché, Equal Opportunity Advisor, Inspector General NCO, Observer Coach/Trainer, Recruiter, Senior Drill Sergeant, Senior Drill Sergeant Leader, SHARP Master Advocate, SARC, Senior Instructor Writer, Senior Training Developer Writer, Senior Small Group Leader, SRU Platoon Sergeant, Detachment Sergeant, Operations NCO, NCOIC, Platoon Sergeant

MSG: N/A



MOS 68F

TRAINING

Most-qualified looks like:

SSG: EFMB, National Physical Therapist Assistant Exam (NPTAE), National Strength & Conditioning Association, Certified Personal Trainer (NSCA-CPT)

SFC: EFMB, National Physical Therapist Assistant Exam (NPTAE), National Strength & Conditioning Association, Certified Personal Trainer (NSCA-CPT)

MSG: N/A

Highly qualified looks like:

SSG: Air Assault, Airborne, EOL, MFT, MRT, SHARP, P3T Leader

SFC: Air Assault, Airborne, Battle Staff, EOA, MFT, MRT, SHARP, P3T Leader

MSG: N/A

OTHER INDICATORS

Most-qualified looks like:

SSG: Active Audie Murphy or SGT Morales Club Member, awarded MOVSM for volunteer service, Army Best Medic Competitor, NCO of the Quarter/Year (**all annotated on NCOER**)

SFC: Active Audie Murphy or SGT Morales Club Member, awarded MOVSM for volunteer service, Army Best Medic Competitor, NCO of the Quarter/Year (**all annotated on NCOER**)

MSG: N/A



U.S. ARMY

MOS 68G Progression Chart

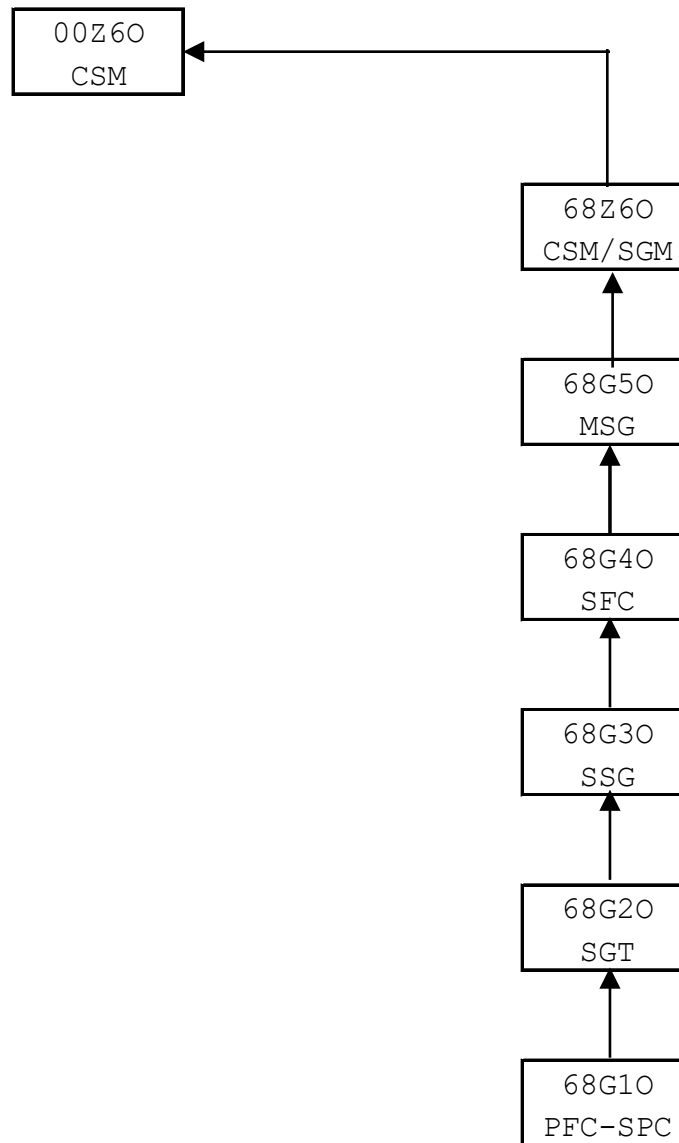



68G Talent Development Model

Years of Service	2	4	6	8	10	12	14	16	18	20	22	24	26	28
Rank														
Key Leadership Position	PATIENT ADMIN SPEC PMC PT MVMT CNTLR 8Y-CERT MEDICAL CODER		PAT ADMIN NCO PAT SVCS NCO JT MED REGULATOR PMC PT MVMT CNTLR 8Y-CERT MEDICAL CODER		MEDICAL RECORDS NCO MED RECORD SUPV PATIENT ADMIN NCO PMC PT MVMT CNTLR 8Y-CERT MEDICAL CODER INSTRUCTOR MTTF PATIENT ADMIN OC/T TRAINING DEV/WRITER SGL, SQUAD LEADER		PATIENT ADMIN NCO STAFF ASSISTANT (PECC) NCOIC ADMIN/FIN/UDM/SC INSTRUCTOR SGL		PAT ADMIN NCO PATIENT ADMIN NCO INSTRUCTOR FIRST SERGEANT					
Military/Civilian Education	DLC I BLC 30 SEMESTER HOURS		DLC II ALC ASSOCIATE DEGREE		DLC III SLC ASSOCIATE DEGREE		DLC IV MLC BACHELOR'S DEGREE		DLC V SMC BACHELOR'S DEGREE		NATIONAL HEALTHCARE ASSOCIATION (NHA), CERTIFIED MEDICAL ADMINISTRATIVE ASSISTANT (CMAA) CERTIFIED PROFESSIONAL IN HEALTHCARE INFORMATION & MANAGEMENT SYSTEMS (CPHIMS), CERTIFIED ELECTRONIC HEALTH RECORD SPECIALIST (CEHRS)			
Critical Leadership Development					OPERATIONS NCO, NCOIC				FIRST SERGEANT		SECTION LEADER / SQUAD LEADER DETACHMENT SERGEANT PLATOON SERGEANT			
Broadening Opportunities			RECRUITER				DRILL SERGEANT		SDS, SDS LEADER, SGL, SSSL, SRU PSG		INSTRUCTOR/WRITER, SGL, SOLDIER RECOVERY UNIT (SRU) SQUAD LEADER ATTACHÉ, EOA, IG NCO, OC/T, SARC, SHARP MASTER ADVOCATE, CHIEF INSTRUCTOR/WRITER, CHIEF TRAINING DEVELOPER/WRITER, MEO INSTRUCTOR, SENIOR INSTRUCTOR/WRITER, SENIOR TRAINING DEVELOPER/WRITER			
Military Training	8Y-CERTIFIED MEDICAL CODER, EXPERT FIELD MEDICAL BADGE, AIR ASSAULT, AIRBORNE, RANGER													
					MRT, MFT									
			EOL, UPL, SUSTAINMENT AUTOMATION SUPPORT MANAGEMENT OFFICE (SASMO)											
					BATTLE STAFF, P3T LEADER									



MOS 68G

The Patient Administration Specialist supervises or performs administrative duties in patient administration division of hospital or other medical activity.

LEADERSHIP POSITIONS

Most-qualified looks like:

SSG: 24 to 48 months as a Squad Leader, Section Sergeant, NCOIC, Patient Administration NCO

SFC: 24 to 36 months as a Platoon Sergeant, Detachment Sergeant

MSG: 18 to 36 months as a First Sergeant

CSM/SGM: N/A

Highly qualified looks like:

SSG: Patient Administration NCO

SFC: Senior Patient Administration NCO

MSG: Chief Patient Administration NCO

CSM/SGM: N/A



MOS 68G

PHYSICAL FITNESS

Most-qualified looks like:

SSG: 540 ACFT score or above with 90 points in each event

SFC: 540 ACFT score or above with 90 points in each event

MSG: 540 ACFT score or above with 90 points in each event

CSM/SGM: N/A

Highly qualified looks like:

SSG: 480 ACFT score or above with 80 points in each event

SFC: 480 ACFT score or above with 80 points in each event

MSG: 480 ACFT score or above with 80 points in each event

MILITARY/CIVILIAN EDUCATION

Most-qualified looks like:

SSG: Exceeded ALC Course Standards, Leadership Award, Distinguished Honor/Honor Graduate, AA Degree

SFC: Exceeded SLC Course Standards, Leadership Award, Distinguished Honor/Honor Graduate, BS Degree

MSG: Exceeded MLC Course Standards, Leadership Award, Distinguished Honor/Honor Graduate, MS Degree

Highly qualified looks like:

SSG: Exceeded ALC Course Standards, Commandant's List, >60 college semester hours

SFC: Exceeded SLC Course Standards, Commandant's List, AA Degree

MSG: Exceeded MLC Course Standards, Commandant's List, >90 college semester hours towards BS Degree



MOS 68G

ASSIGNMENTS (Broadening and Critical Leader Development) PROPONENT SPECIFIC CHALLENGING / HIGH RISK

SSG: Drill Sergeant, Instructor Writer, Recruiter, Small Group Leader, SRU Squad Leader, NCOIC, Operations NCO, Section/Squad Leader

SFC: Attaché, Equal Opportunity Advisor, Inspector General NCO, Observer Coach/Trainer, Recruiter, Senior Drill Sergeant, Senior Drill Sergeant Leader, SHARP Master Advocate, SARC, Senior Instructor Writer, Senior Training Developer Writer, Senior Small Group Leader, SRU Platoon Sergeant, Detachment Sergeant, Operations NCO, NCOIC, Platoon Sergeant

MSG: Attaché, Chief Instructor Writer, Chief Training Developer Writer, Equal Opportunity Advisor, Inspector General NCO, SHARP Master Advocate, SARC, First Sergeant

CSM/SGM: N/A



MOS 68G

TRAINING

Most-qualified looks like:

SSG: EFMB, Certified Coding Specialist (CCS)

SFC: EFMB, Certified Coding Specialist (CCS), Certified Medical Administrative Assistant (CMAA)

MSG: EFMB, Certified Coding Specialist (CCS), Certified Professional in Healthcare Information & Management Systems (CPHIMS), Certified Electronic Health Record Specialist (CEHRS)

CSM/SGM: N/A

Highly qualified looks like:

SSG: Air Assault, Airborne, EOL, MFT, MRT, SHARP, P3T Leader

SFC: Air Assault, Airborne, Battle Staff, EOA, MFT, MRT, SHARP, P3T Leader

MSG: Air Assault, Airborne, Battle Staff, EOA, MFT, MRT, SHARP

CSM/SGM: N/A

OTHER INDICATORS

Most-qualified looks like:

SSG: Active Audie Murphy or SGT Morales Club Member, awarded MOVSM for volunteer service, Army Best Medic Competitor, NCO of the Quarter/Year **(all annotated on NCOER)**

SFC: Active Audie Murphy or SGT Morales Club Member, awarded MOVSM for volunteer service, Army Best Medic Competitor, NCO of the Quarter/Year **(all annotated on NCOER)**

MSG: Award of the Order of Military Medical Merit (Regimental Award), Other Regimental Awards **(annotated on NCOER)**



U.S. ARMY

MOS 68H Progression Chart

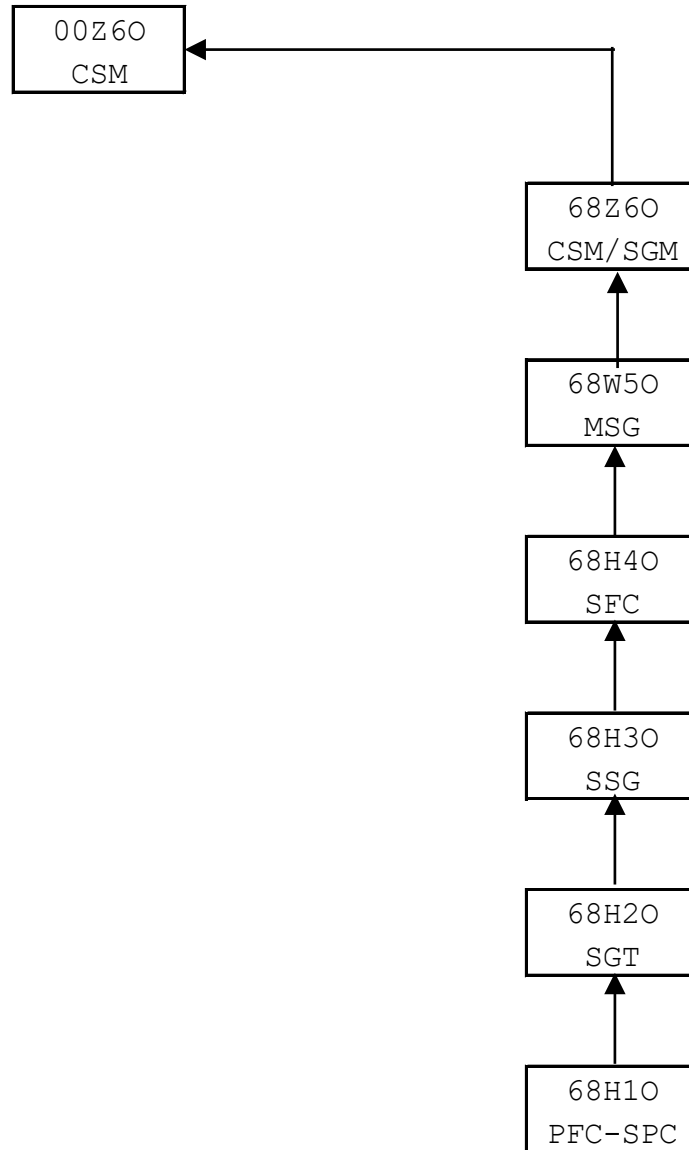



68H Talent Development Model (Merges into 68W at E8/MSG)

Years of Service	2	4	6	8	10	12	14	16	18	20	22	24	26	28
Rank														
Key Leadership Position	OPTICAL LAB SPEC		OPTICAL LAB SGT		OPTICAL LAB NCO INSTRUCTOR DRILL SERGEANT			SR OPTICAL LAB NCO SR TRAINING DEVELOPER INSTRUCTOR						
Military/Civilian Education	DLC I		DLC II		DLC III			DLC IV						
	BLC		ALC		SLC			MLC						
	30 SEMESTER HOURS				ASSOCIATE DEGREE									
	AMERICAN BOARD OF OPTICIANRY BASIC - NATIONAL OPTICIANRY COMPETENCY EXAM (NOCE), NATIONAL CONTACT LENS EXAMINERS BASIC CERTIFICATION - CONTACT LENS REGISTRY EXAM (CLRE)													
Critical Leadership Development	<div style="border: 1px solid red; padding: 5px; text-align: center; color: red;">OPERATIONS NCO, NCOIC</div> <div style="display: flex; justify-content: space-around; margin-top: 5px;"> <div style="border: 1px solid red; padding: 5px; text-align: center; color: red;">SECTION LEADER / SQUAD LEADER</div> <div style="border: 1px solid red; padding: 5px; text-align: center; color: red;">DETACHMENT SERGEANT PLATOON SERGEANT</div> </div>													
Broadening Opportunities	<div style="border: 1px solid yellow; padding: 5px; text-align: center; color: black;">RECRUITER</div> <div style="display: flex; justify-content: space-between; margin-top: 5px;"> <div style="border: 1px solid yellow; padding: 5px; text-align: center; color: black;">DRILL SERGEANT</div> <div style="border: 1px solid yellow; padding: 5px; text-align: center; color: black;">SDS, SDS LEADER, SGL, SSGL, SRU PSG, OC/T,</div> </div> <div style="display: flex; justify-content: space-between; margin-top: 5px;"> <div style="border: 1px solid yellow; padding: 5px; text-align: center; color: black;">INSTRUCTOR/WRITER, SGL, SOLDIER RECOVERY UNIT (SRU) SQUAD LEADER</div> <div style="border: 1px solid yellow; padding: 5px; text-align: center; color: black;">ATTACHÉ, EOA, MEO INSTRUCTOR, IG NCO, SARC, SHARP MASTER ADVOCATE, CHIEF INSTRUCTOR/WRITER, CHIEF TRAINING DEVELOPER/WRITER, SENIOR INSTRUCTOR/WRITER, SENIOR TRAINING DEVELOPER/WRITER</div> </div>													
Military Training	<div style="border: 1px solid green; padding: 5px; text-align: center; color: black;">EXPERT FIELD MEDICAL BADGE, AIR ASSAULT, AIRBORNE, RANGER</div> <div style="border: 1px solid green; padding: 5px; text-align: center; color: black; margin-top: 5px;">EOL, UPL, MRT, MFT</div> <div style="border: 1px solid green; padding: 5px; text-align: center; color: black; margin-top: 5px;">BATTLE STAFF, P3T LEADER</div>													



MOS 68H

The Optical Laboratory Specialist assembles spectacles utilizing pre-surfaced single-vision lens; surfaces multi-vision lens and assembles multi-vision spectacles; repairs and fabricates spectacles and supervises optical laboratory personnel.

LEADERSHIP POSITIONS

Most-qualified looks like:

SSG: 24 to 48 months as a Squad Leader, Section Sergeant, NCOIC, Optical Laboratory NCO

SFC: 24 to 36 months as a Detachment Sergeant, Platoon Sergeant, Senior Optical Laboratory NCO

MSG: N/A

Highly qualified looks like:

SSG: Optical Laboratory NCO

SFC: Senior Optical Laboratory NCO

MSG: N/A



MOS 68H

PHYSICAL FITNESS

Most-qualified looks like:

SSG: 540 ACFT score or above with 90 points in each event

SFC: 540 ACFT score or above with 90 points in each event

MSG: N/A

Highly qualified looks like:

SSG: 480 ACFT score or above with 80 points in each event

SFC: 480 ACFT score or above with 80 points in each event

MSG: N/A

MILITARY/CIVILIAN EDUCATION

Most-qualified looks like:

SSG: Exceeded ALC Course Standards, Leadership Award, Distinguished Honor/Honor Graduate, AA Degree

SFC: Exceeded SLC Course Standards, Leadership Award, Distinguished Honor/Honor Graduate, BS Degree

MSG: N/A

Highly qualified looks like:

SSG: Exceeded ALC Course Standards, Commandant's List, >60 college semester hours

SFC: Exceeded SLC Course Standards, Commandant's List, AA Degree

MSG: N/A



MOS 68H

ASSIGNMENTS (Broadening and Critical Leader Development)
PROPONENT SPECIFIC CHALLENGING / HIGH RISK

SSG: Drill Sergeant, Instructor Writer, Recruiter, Small Group Leader, SRU Squad Leader, NCOIC, Operations NCO, Section/Squad Leader

SFC: Attaché, Equal Opportunity Advisor, Inspector General NCO, Observer Coach/Trainer, Recruiter, Senior Drill Sergeant, Senior Drill Sergeant Leader, SHARP Master Advocate, SARC, Senior Instructor Writer, Senior Training Developer Writer, Senior Small Group Leader, SRU Platoon Sergeant, Detachment Sergeant, Operations NCO, NCOIC, Platoon Sergeant

MSG: N/A



MOS 68H

TRAINING

Most-qualified looks like:

SSG: EFMB, American Board of Opticianry Basic Certification- National Opticianry Competency Exam (NOCE)

SFC: EFMB, American Board of Opticianry Basic Certification- National Opticianry Competency Exam (NOCE), National Contact Lens Examiners Basic Certification- Contact Lens Registry Exam (CLRE)

MSG: N/A

Highly qualified looks like:

SSG: Air Assault, Airborne, EOL, MFT, MRT, SHARP, P3T Leader

SFC: Air Assault, Airborne, Battle Staff, EOA, MFT, MRT, SHARP, P3T Leader

MSG: N/A

OTHER INDICATORS

Most-qualified looks like:

SSG: Active Audie Murphy or SGT Morales Club Member, awarded MOVSM for volunteer service, Army Best Medic Competitor, NCO of the Quarter/Year (**all annotated on NCOER**)

SFC: Active Audie Murphy or SGT Morales Club Member, awarded MOVSM for volunteer service, Army Best Medic Competitor, NCO of the Quarter/Year (**all annotated on NCOER**)

MSG: Award of the Order of Military Medical Merit (Regimental Award) (**annotated on NCOER**)



U.S. ARMY

MOS 68J Progression Chart

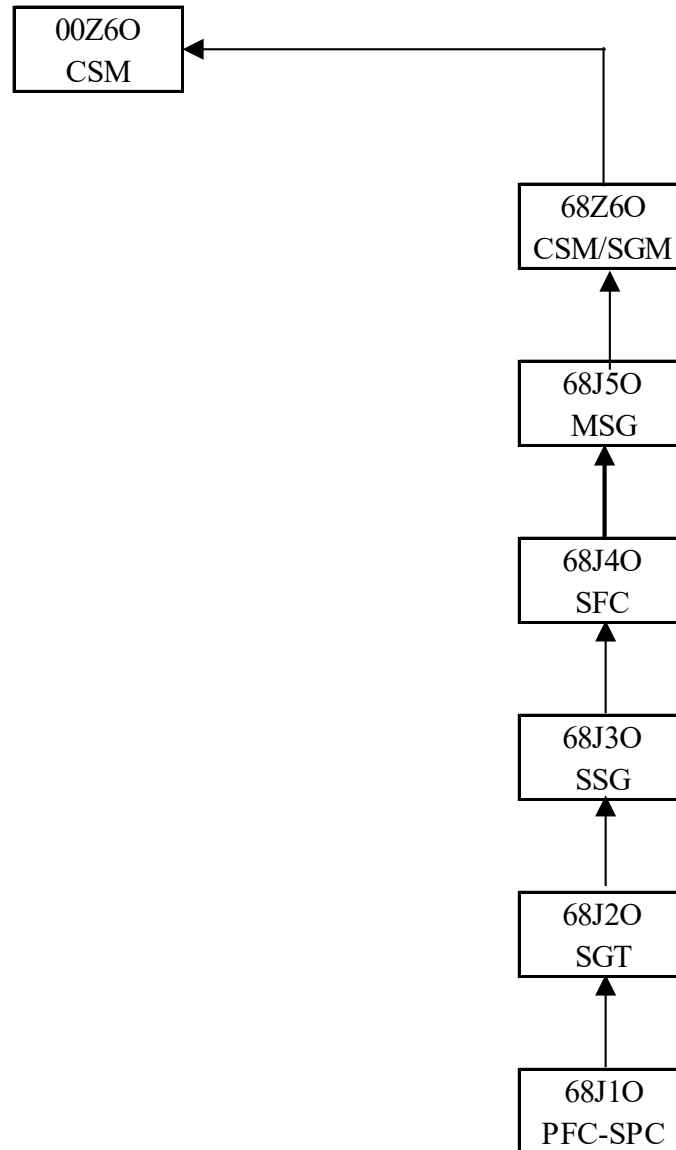



68J Talent Development Model

Years of Service	2	4	6	8	10	12	14	16	18	20	22	24	26	28
Rank														
Key Leadership Position	MED LOG SPEC		MED LOG NCO MED LOG SGT		MED LOG NCO MED LOG PLANS SR NCO STOCK CONTROL SUPV INSTRUCTOR/WRITER, INSTRUCTOR SGL DRILL SERGEANT RECRUITER		MED LOG NCO, DETACHMENT SERGEANT PLATOON SERGEANT MTTF SR MED LOG OC/T SR INSTRUCTOR/WRITER SR TRAINING DEVELOPER INSTRUCTOR, SGL		SR MED LOG NCO OPS NCO MED LOG NCO FIRST SERGEANT MED SUPPLY NCO					
Military/Civilian Education	DLC I BLC		DLC II ALC		DLC III SLC		DLC IV MLC		DLC V SMC					
	30 SEMESTER HOURS			ASSOCIATE DEGREE				BACHELOR'S DEGREE						
	AMERICAN PRODUCTION & INVENTORY CONTROL SOCIETY (APICS) CERTIFIED IN PRODUCTION & INVENTORY MANAGEMENT (CPIM), CERTIFIED SUPPLY CHAIN PROFESSIONAL (CSCP)													
Critical Leadership Development	<div style="border: 1px solid red; padding: 5px; display: inline-block; margin: 5px;">OPERATIONS NCO, NCOIC</div> <div style="border: 1px solid red; padding: 5px; display: inline-block; margin: 5px;">SECTION LEADER / SQUAD LEADER</div> <div style="border: 1px solid red; padding: 5px; display: inline-block; margin: 5px;">DETACHMENT SERGEANT PLATOON SERGEANT</div> <div style="border: 1px solid red; padding: 5px; display: inline-block; margin: 5px;">FIRST SERGEANT</div>													
Broadening Opportunities	<div style="border: 1px solid yellow; padding: 5px; display: inline-block; margin: 5px;">RECRUITER</div> <div style="border: 1px solid yellow; padding: 5px; display: inline-block; margin: 5px;">DRILL SERGEANT</div> <div style="border: 1px solid yellow; padding: 5px; display: inline-block; margin: 5px;">SDS, SDS LEADER, SGL, SSSL, SRU PSG</div> <div style="border: 1px solid yellow; padding: 5px; display: inline-block; margin: 5px;">INSTRUCTOR/WRITER, SGL, SOLDIER RECOVERY UNIT (SRU) SQUAD LEADER</div> <div style="border: 1px solid yellow; padding: 5px; display: inline-block; margin: 5px;">ATTACHÉ, EOA, IG NCO, OC/T, SARC, SHARP MASTER ADVOCATE, CHIEF INSTRUCTOR/WRITER, CHIEF TRAINING DEVELOPER/WRITER, MEO INSTRUCTOR, SENIOR INSTRUCTOR/WRITER, SENIOR TRAINING DEVELOPER/WRITER</div>													
Military Training	<div style="border: 1px solid green; padding: 5px; display: inline-block; margin: 5px;">EXPERT FIELD MEDICAL BADGE, AIR ASSAULT, AIRBORNE, RANGER</div> <div style="border: 1px solid green; padding: 5px; display: inline-block; margin: 5px;">MRT, MFT</div> <div style="border: 1px solid green; padding: 5px; display: inline-block; margin: 5px;">EOL, UPL, SUSTAINMENT AUTOMATION SUPPORT MANAGEMENT OFFICE (SASMO)</div> <div style="border: 1px solid green; padding: 5px; display: inline-block; margin: 5px;">BATTLE STAFF, P3T LEADER, OPERATIONAL CONTRACT SUPPORT (OCS)</div>													



MOS 68J

The Medical Logistics Specialist performs or supervises requisitioning, receipt, inventory management, storage, preservation, issue, salvage, destruction stock control, quality control, property management, repair parts management, inspection, packing and shipping, care, segregation and accounting of medical supplies and equipment.

LEADERSHIP POSITIONS

Most-qualified looks like:

SSG: 24 to 48 months as a Squad Leader, Section Sergeant, NCOIC, Medical Logistics NCO

SFC: 24 to 36 months as a Platoon Sergeant, Detachment Sergeant

MSG: 18 to 36 months as a First Sergeant

CSM/SGM: N/A

Highly qualified looks like:

SSG: Medical Logistics NCO, Stock Control Supervisor

SFC: Senior Medical Logistics NCO

MSG: Chief Medical Logistics NCO, Operations Sergeant

CSM/SGM: N/A



MOS 68J

PHYSICAL FITNESS

Most-qualified looks like:

SSG: 540 ACFT score or above with 90 points in each event

SFC: 540 ACFT score or above with 90 points in each event

MSG: 540 ACFT score or above with 90 points in each event

CSM/SGM: N/A

Highly qualified looks like:

SSG: 480 ACFT score or above with 80 points in each event

SFC: 480 ACFT score or above with 80 points in each event

MSG: 480 ACFT score or above with 80 points in each event

MILITARY/CIVILIAN EDUCATION

Most-qualified looks like:

SSG: Exceeded ALC Course Standards, Leadership Award, Distinguished Honor/Honor Graduate, AA Degree

SFC: Exceeded SLC Course Standards, Leadership Award, Distinguished Honor/Honor Graduate, BS Degree

MSG: Exceeded MLC Course Standards, Leadership Award, Distinguished Honor Graduate, MS Degree

Highly qualified looks like:

SSG: Exceeded ALC Course Standards, Commandant's List, >60 college semester hours

SFC: Exceeded SLC Course Standards, Commandant's List, AA Degree

MSG: Exceeded MLC Course Standards, Commandant's List, >90 college semester hours towards BS



MOS 68J

ASSIGNMENTS (Broadening and Critical Leader Development) **PROPONENT SPECIFIC CHALLENGING / HIGH RISK**

SSG: Drill Sergeant, Instructor Writer, Recruiter, Small Group Leader, SRU Squad Leader, **NCOIC, Operations NCO, Section/Squad Leader**

SFC: Attaché, Equal Opportunity Advisor, Inspector General NCO, Observer Coach/Trainer, Recruiter, Senior Drill Sergeant, Senior Drill Sergeant Leader, SHARP Master Advocate, SARC, Senior Instructor Writer, Senior Training Developer Writer, Senior Small Group Leader, SRU Platoon Sergeant, **Detachment Sergeant, Operations NCO, NCOIC, Platoon Sergeant**

MSG: Attaché, Chief Instructor Writer, Chief Training Developer Writer, Equal Opportunity Advisor, Inspector General NCO, SHARP Master Advocate, SARC, **First Sergeant**

CSM/SGM: N/A



MOS 68J

TRAINING

Most-qualified looks like:

SSG: EFMB, Certified in Production and Inventory Management (CPIM)

SFC: EFMB, Certified in Production and Inventory Management (CPIM), Certified Professional Logistician (CPL)

MSG: EFMB, Certified in Production and Inventory Management (CPIM), Certified Professional Logistician (CPL)

CSM/SGM: N/A

Highly qualified looks like:

SSG: Air Assault, Airborne, EOL, MFT, MRT, SHARP, P3T Leader

SFC: Air Assault, Airborne, Battle Staff, EOA, MFT, MRT, SHARP, P3T Leader

MSG: Air Assault, Airborne, MRT, MFT, Battle Staff

CSM/SGM: N/A

OTHER INDICATORS

Most-qualified looks like:

SSG: Active Audie Murphy or SGT Morales Club Member, awarded MOVSM for volunteer service, Army Best Medic Competitor, NCO of the Quarter/Year **(all annotated on NCOER)**

SFC: Active Audie Murphy or SGT Morales Club Member, awarded MOVSM for volunteer service, Army Best Medic Competitor, NCO of the Quarter/Year **(all annotated on NCOER)**

MSG: Award of the Order of Military Medical Merit (Regimental Award), Other Regimental Awards



U.S. ARMY

MOS 68K Progression Chart

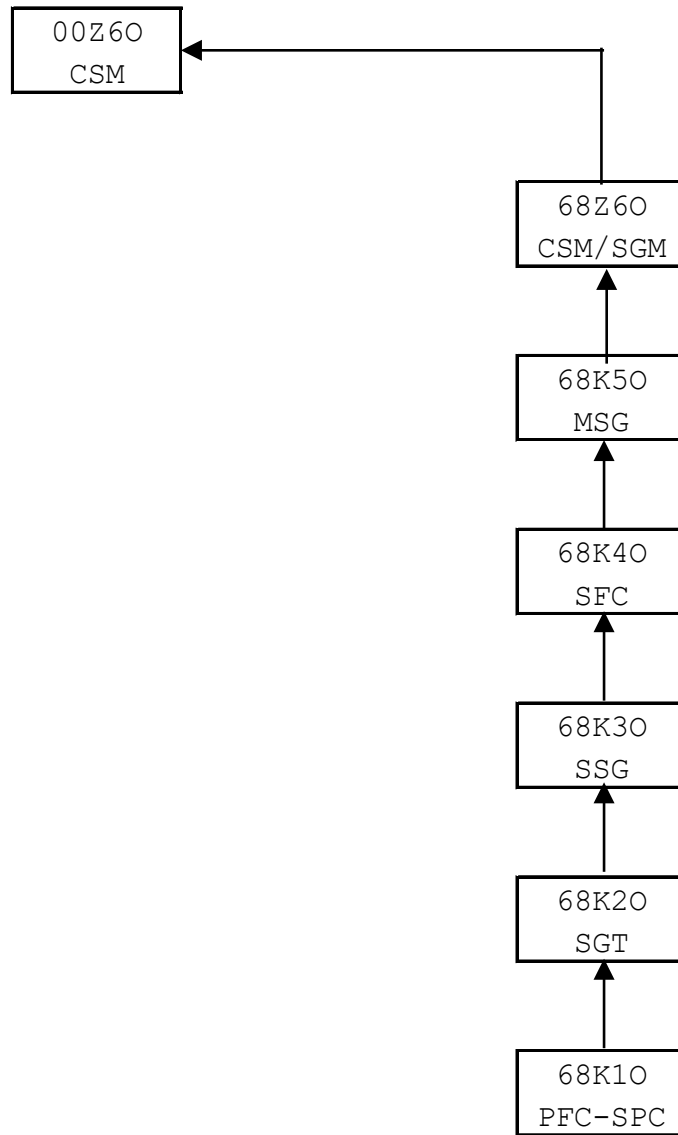



68K Talent Development Model

Years of Service	2	4	6	8	10	12	14	16	18	20	22	24	26	28
Rank														
Key Leadership Position	MED LAB SPEC BIO MED RESEARCH SPEC		MED LAB SGT MED LAB NCO		MED LAB NCO INSTRUCTOR INSTRUCTOR/WRITER SQUAD LEADER SGL DRILL SERGEANT RECRUITER		SR MED LAB NCO LAB NCO DETACHMENT SERGEANT MTTF MED LAB OC/T SR TRAINING DEV/WRITER SR INSTRUCTOR/WRITER INSTRUCTOR		SR MED LAB NCO MED LAB TECH SR TRAINING DEV/WRITER CHIEF INSTRUCTOR FIRST SERGEANT					
Military/Civilian Education	DLC I BLC		DLC II ALC		DLC III SLC		DLC IV MLC		DLC V SMC					
	30 SEMESTER HOURS		ASSOCIATE DEGREE				BACHELOR'S DEGREE							
	AMERICAN SOCIETY FOR CLINICAL PATHOLOGY (ASCP) MEDICAL LABORATORY TECHNICIAN, MLT (ASCP) AMERICAN MEDICAL TECHNOLOGISTS (AMT) MEDICAL LABORATORY TECHNICIAN (MLT)													
Critical Leadership Development	<div style="border: 1px solid red; padding: 5px; display: inline-block; margin: 5px;">OPERATIONS NCO, NCOIC</div> <div style="border: 1px solid red; padding: 5px; display: inline-block; margin: 5px;">SECTION LEADER / SQUAD LEADER</div> <div style="border: 1px solid red; padding: 5px; display: inline-block; margin: 5px;">DETACHMENT SERGEANT PLATOON SERGEANT</div> <div style="border: 1px solid red; padding: 5px; display: inline-block; margin: 5px;">FIRST SERGEANT</div>													
Broadening Opportunities	<div style="border: 1px solid yellow; padding: 5px; display: inline-block; margin: 5px;">RECRUITER</div> <div style="border: 1px solid yellow; padding: 5px; display: inline-block; margin: 5px;">DRILL SERGEANT</div> <div style="border: 1px solid yellow; padding: 5px; display: inline-block; margin: 5px;">SDS, SDS LEADER, SGL, SSSL, SRU PSG</div> <div style="border: 1px solid yellow; padding: 5px; display: inline-block; margin: 5px;">INSTRUCTOR/WRITER, SGL, SOLDIER RECOVERY UNIT (SRU) SQUAD LEADER</div> <div style="border: 1px solid yellow; padding: 5px; display: inline-block; margin: 5px;">ATTACHÉ, EOA, IG NCO, OC/T, SARC, SHARP MASTER ADVOCATE, CHIEF INSTRUCTOR/WRITER, CHIEF TRAINING DEVELOPER/WRITER, MEO INSTRUCTOR, SENIOR INSTRUCTOR/WRITER, SENIOR TRAINING DEVELOPER/WRITER</div>													
Military Training	<div style="border: 1px solid green; padding: 5px; display: inline-block; margin: 5px;">EXPERT FIELD MEDICAL BADGE, AIR ASSAULT, AIRBORNE, RANGER</div> <div style="border: 1px solid green; padding: 5px; display: inline-block; margin: 5px;">EOL, UPL, MRT, MFT</div> <div style="border: 1px solid green; padding: 5px; display: inline-block; margin: 5px;">BATTLE STAFF, P3T LEADER</div>													



MOS 68K

The medical laboratory specialist performs blood banking procedures and elementary and advanced examinations of biological and environmental specimens to aid in the diagnosis, treatment, and prevention of disease and other medical disorders.

LEADERSHIP POSITIONS

Most-qualified looks like:

SSG: 24 to 48 months as a Squad Leader, Section Sergeant, NCOIC, Medical Lab NCO

SFC: 24 to 36 months as a Platoon Sergeant, Detachment Sergeant, Senior Medical Lab NCO

MSG: 18 to 36 months as a First Sergeant

CSM/SGM: N/A

Highly qualified looks like:

SSG: Medical Lab NCO, Section Chief

SFC: Medical Lab NCO

MSG: Senior Medical Lab NCO

CSM/SGM: N/A



MOS 68K

PHYSICAL FITNESS

Most-qualified looks like:

SSG: 540 ACFT score or above with 90 points in each event

SFC: 540 ACFT score or above with 90 points in each event

MSG: 540 ACFT score or above with 90 points in each event

CSM/SGM: N/A

Highly qualified looks like:

SSG: 480 ACFT score or above with 80 points in each event

SFC: 480 ACFT score or above with 80 points in each event

MSG: 480 ACFT score or above with 80 points in each event

MILITARY/CIVILIAN EDUCATION

Most-qualified looks like:

SSG: Exceeded ALC Course Standards, Leadership Award, Distinguished Honor/Honor Graduate, AA Degree

SFC: Exceeded SLC Course Standards, Leadership Award, Distinguished Honor/Honor Graduate, BS Degree

MSG: Exceeded MLC Course Standards, Leadership Award, Distinguished Honor Graduate, MS Degree

Highly qualified looks like:

SSG: Exceeded ALC Course Standards, Commandant's List, >60 college semester hours

SFC: Exceeded SLC Course Standards, Commandant's List, AA Degree

MSG: Exceeded MLC Course Standards, Commandant's List, >90 college semester hours towards BS Degree



MOS 68K

ASSIGNMENTS (Broadening and Critical Leader Development)
PROPONENT SPECIFIC CHALLENGING / HIGH RISK

SSG: Drill Sergeant, Instructor Writer, Recruiter, Small Group Leader, SRU Squad Leader, NCOIC, Operations NCO, Section/Squad Leader

SFC: Attaché, Equal Opportunity Advisor, Inspector General NCO, Observer Coach/Trainer, Recruiter, Senior Drill Sergeant, Senior Drill Sergeant Leader, SHARP Master Advocate, SARC, Senior Instructor Writer, Senior Training Developer Writer, Senior Small Group Leader, SRU Platoon Sergeant, Detachment Sergeant, Operations NCO, NCOIC, Platoon Sergeant

MSG: Attaché, Chief Instructor Writer, Chief Training Developer Writer, Equal Opportunity Advisor, Inspector General NCO, SHARP Master Advocate, SARC, First Sergeant

CSM/SGM: N/A



U.S. ARMY

MOS 68K

TRAINING

Most-qualified looks like:

SSG: EFMB, Medical Laboratory Technician (MLT)

SFC: EFMB, Medical Laboratory Technician (MLT)

MSG: EFMB, Medical Laboratory Technician (MLT)

CSM/SGM: N/A

Highly qualified looks like:

SSG: Air Assault, Airborne, EOL, MFT, MRT, SHARP, P3T Leader

SFC: Air Assault, Airborne, Battle Staff, EOA, MFT, MRT, SHARP, P3T Leader

MSG: Air Assault, Airborne, MRT , MFT, Battle Staff

CSM/SGM: N/A

OTHER INDICATORS

Most-qualified looks like:

SSG: Active Audie Murphy or SGT Morales Club Member, awarded MOVSM for volunteer service, Army Best Medic Competitor, NCO of the Quarter/Year **(all annotated on NCOER)**

SFC: Active Audie Murphy or SGT Morales Club Member, awarded MOVSM for volunteer service, Army Best Medic Competitor, NCO of the Quarter/Year **(all annotated on NCOER)**

MSG: Award of the Order of Military Medical Merit (Regimental Award), Other Regimental Awards **(annotated on NCOER)**



U.S. ARMY

MOS 68L Progression Chart

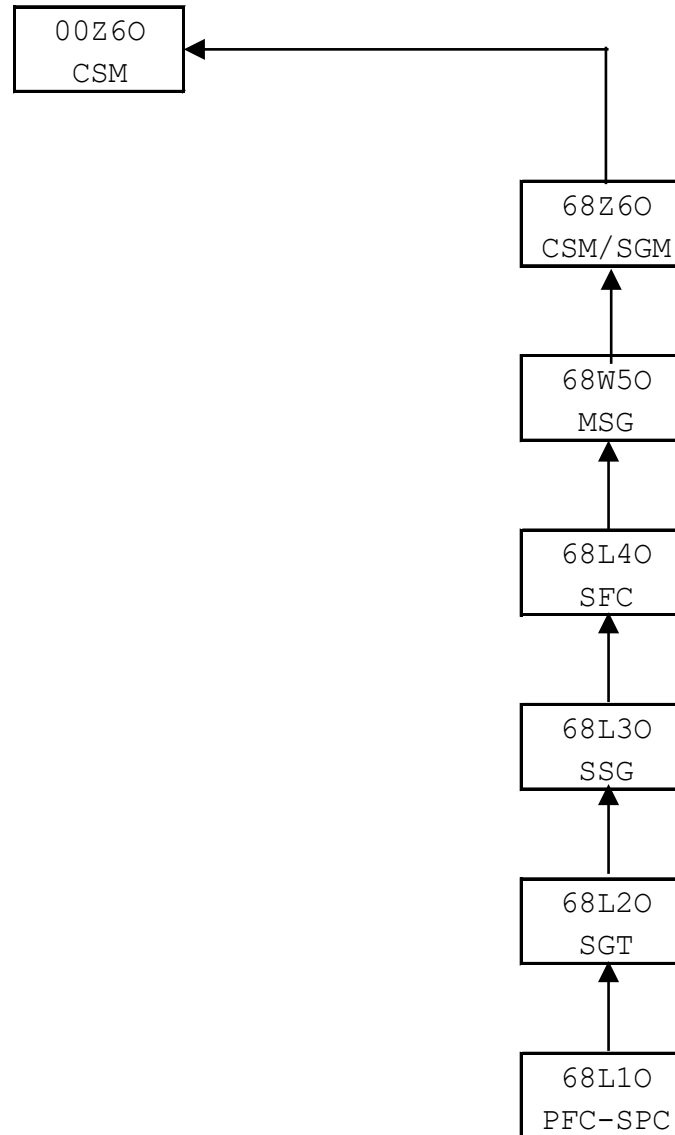



U.S. ARMY

68L Talent Development Model (Merges into 68W at E8/MSG)

Years of Service	2	4	6	8	10	12	14	16	18	20	22	24	26	28
Rank														
Key Leadership Position	OCCUPATIONAL THERAPY SPEC OT SPEC H2F SPEC		OCCUPATIONAL THERAPY SGT OCCUPATIONAL THERAPY NCO INSTRUCTOR/WRITER H2F NCO		OCCUPATIONAL THERAPY NCO INSTRUCTOR INSTRUCTOR/WRITER H2F NCO		OCCUPATIONAL THERAPY NCO INSTRUCTOR INSTRUCTOR/WRITER							
Military/Civilian Education	DLC I ASSOCIATE DEGREE		DLC II BLC		DLC III ALC		DLC IV SLC		DLC IV MLC BACHELOR'S DEGREE					
Critical Leadership Development					OPERATIONS NCO, NCOIC SECTION LEADER / SQUAD LEADER DETACHMENT SERGEANT PLATOON SERGEANT									
Broadening Opportunities			RECRUITER DRILL SERGEANT, H2F				INSTRUCTOR/WRITER, SGL, SOLDIER RECOVERY UNIT (SRU) SQUAD LEADER SDS, SDS LEADER, SGL, SSGL, SRU PSG, OC/T, ATTACHÉ, EOA, MEO INSTRUCTOR, IG NCO, SARC, SHARP MASTER ADVOCATE, CHIEF INSTRUCTOR/WRITER, CHIEF TRAINING DEVELOPER/WRITER, SENIOR INSTRUCTOR/WRITER, SENIOR TRAINING DEVELOPER/WRITER							
Military Training	EXPERT FIELD MEDICAL BADGE, AIR ASSAULT, AIRBORNE, RANGER													
							EOL, UPL, MRT, MFT							
					BATTLE STAFF, P3T LEADER									



MOS 68L

The Occupational Therapy Specialist, under the direction of a registered military occupational therapist, supervises or interviews, tests, plans treatment programs, and teaches and assists patients to facilitate maximum recovery by decreasing physical and mental disabilities resulting from illness or trauma, prevent injury, and promote life-style modification to improve fitness.

LEADERSHIP POSITIONS

Most-qualified looks like:

SSG: 24 to 48 months as a Squad Leader, Section Sergeant, NCOIC, Occupational Therapy NCO

SFC: 24 to 36 months as a Platoon Sergeant, Detachment Sergeant

MSG: N/A

Highly qualified looks like:

SSG: Occupational Therapy SGT

SFC: Senior Occupational Therapy NCO

MSG: N/A



MOS 68L

PHYSICAL FITNESS

Most-qualified looks like:

SSG: 540 ACFT score or above with 90 points in each event

SFC: 540 ACFT score or above with 90 points in each event

MSG: N/A

Highly qualified looks like:

SSG: 480 ACFT score or above with 80 points in each event

SFC: 480 ACFT score or above with 80 points in each event

MSG: N/A

MILITARY/CIVILIAN EDUCATION

Most-qualified looks like:

SSG: Exceeded ALC Course Standards, Leadership Award, Distinguished Honor/Honor Graduate, BS Degree

SFC: Exceeded SLC Course Standards, Leadership Award, Distinguished Honor/Honor Graduate, BS Degree

MSG: N/A

Highly qualified looks like:

SSG: Exceeded ALC Course Standards, Commandant's List, AA Degree

SFC: Exceeded SLC Course Standards, Commandant's List, >90 college semester hours towards BS

MSG: N/A



MOS 68L

ASSIGNMENTS (Broadening and Critical Leader Development)
PROPONENT SPECIFIC CHALLENGING / HIGH RISK

SSG: Drill Sergeant, Holistic Health and Fitness NCO, Instructor Writer, Recruiter, Small Group Leader, SRU Squad Leader, NCOIC, Operations NCO, Section/Squad Leader

SFC: Attaché, Equal Opportunity Advisor, Inspector General NCO, Observer Coach/Trainer, Recruiter, Senior Drill Sergeant, Senior Drill Sergeant Leader, SHARP Master Advocate, SARC, Senior Instructor Writer, Senior Training Developer Writer, Senior Small Group Leader, SRU Platoon Sergeant, Detachment Sergeant, Operations NCO, NCOIC, Platoon Sergeant

MSG: N/A



MOS 68L

TRAINING

Most-qualified looks like:

SSG: EFMB, Certified Occupational Therapy Assistant (COTA)

SFC: EFMB, Certified Occupational Therapy Assistant (COTA)

MSG: N/A

Highly qualified looks like:

SSG: Air Assault, Airborne, EOL, MFT, MRT, SHARP, P3T Leader

SFC: Air Assault, Airborne, Battle Staff, EOA, MFT, MRT, SHARP, P3T Leader

MSG: N/A

OTHER INDICATORS

Most-qualified looks like:

SSG: Active Audie Murphy or SGT Morales Club Member, awarded MOVSM for volunteer service, Army Best Medic Competitor, NCO of the Quarter/Year **(all annotated on NCOER)**

SFC: Active Audie Murphy or SGT Morales Club Member, awarded MOVSM for volunteer service, Army Best Medic Competitor, NCO of the Quarter/Year **(all annotated on NCOER)**

MSG: N/A



U.S. ARMY

MOS 68M Progression Chart

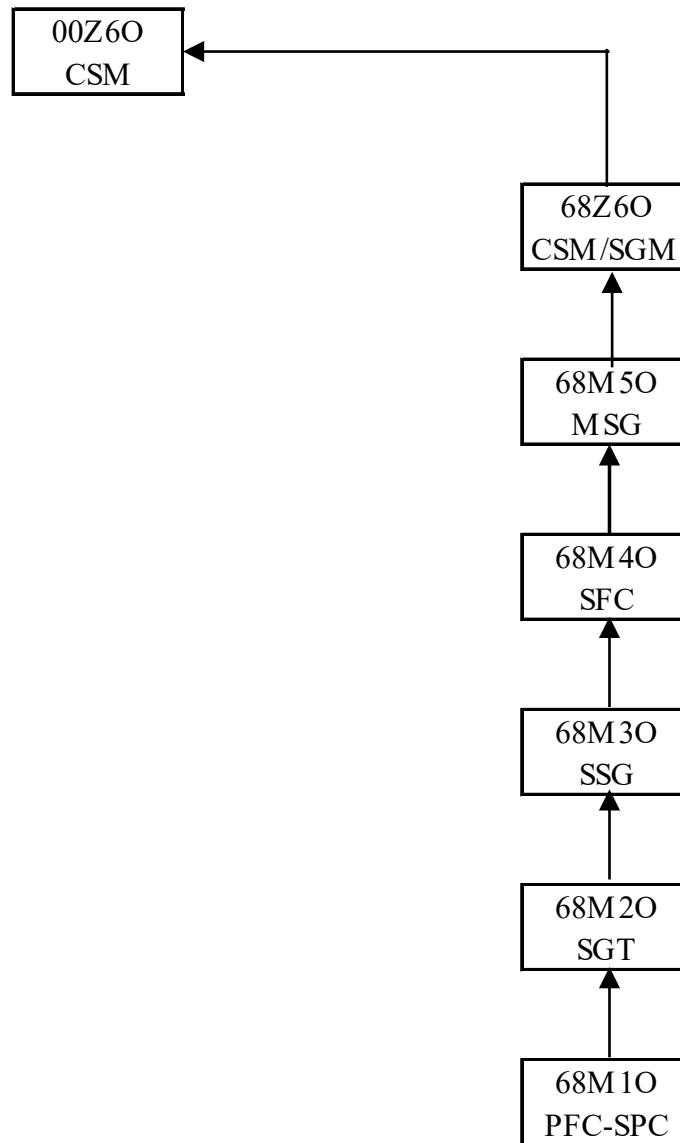



68M Talent Development Model

Years of Service	2	4	6	8	10	12	14	16	18	20	22	24	26	28	
Rank															
Key Leadership Position	NUTRITION CARE SPEC H2F SPEC		NUTRITION CARE SGT H2F NCO		NUTRITION CARE NCO RECRUITER INSTRUCTOR H2F NCO SGL			NUTRITION CARE NCO INSTRUCTOR INSTRUCTOR/WRITER			SR NUTRITION CARE NCO FIRST SERGEANT				
Military/Civilian Education	DLC I BLC		DLC II ALC		DLC III SLC		DLC IV MLC			DLC V SMC					
	30 SEMESTER HOURS			ASSOCIATE DEGREE					BACHELOR'S DEGREE						
	CERTIFIED DIETARY MANAGER - CERTIFIED FOOD PROTECTION PROFESSIONAL (CDM-CFPP), DIETETIC TECHNICIAN, REGISTERED (DTR)														
Critical Leadership Development	<div style="border: 1px solid red; padding: 5px; display: inline-block; margin: 5px;">OPERATIONS NCO, NCOIC</div> <div style="border: 1px solid red; padding: 5px; display: inline-block; margin: 5px;">SECTION LEADER / SQUAD LEADER</div> <div style="border: 1px solid red; padding: 5px; display: inline-block; margin: 5px;">DETACHMENT SERGEANT PLATOON SERGEANT</div> <div style="border: 1px solid red; padding: 5px; display: inline-block; margin: 5px;">FIRST SERGEANT</div>														
Broadening Opportunities	<div style="border: 1px solid yellow; padding: 5px; display: inline-block; margin: 5px;">RECRUITER</div> <div style="border: 1px solid yellow; padding: 5px; display: inline-block; margin: 5px;">DRILL SERGEANT</div> <div style="border: 1px solid yellow; padding: 5px; display: inline-block; margin: 5px;">SDS, SDS LEADER, SGL, SSSL, SRU PSG</div> <div style="border: 1px solid yellow; padding: 5px; display: inline-block; margin: 5px;">H2F NCO, SGL, INSTRUCTOR/WRITER, SOLDIER RECOVERY UNIT (SRU) SQUAD LEADER</div> <div style="border: 1px solid yellow; padding: 5px; display: inline-block; margin: 5px;">ATTACHÉ, EOA, IG NCO, OC/T, SARC, SHARP MASTER ADVOCATE, CHIEF INSTRUCTOR/WRITER, CHIEF TRAINING DEVELOPER/WRITER, MEO INSTRUCTOR, SENIOR INSTRUCTOR/WRITER, SENIOR TRAINING DEVELOPER/WRITER</div>														
Military Training	<div style="border: 1px solid green; padding: 5px; display: inline-block; margin: 5px;">EXPERT FIELD MEDICAL BADGE, AIR ASSAULT, AIRBORNE, RANGER</div> <div style="border: 1px solid green; padding: 5px; display: inline-block; margin: 5px;">EOL, UPL, MRT, MFT</div> <div style="border: 1px solid green; padding: 5px; display: inline-block; margin: 5px;">BATTLE STAFF, P3T LEADER</div>														



MOS 68M

The Nutrition Care Specialist serves as an extender to the AOC 65C (dietitian) by providing medical nutrition care therapy to patients and staff as well as in support of humanitarian missions in field and fixed hospitals.

LEADERSHIP POSITIONS

Most-qualified looks like:

SSG: 24 to 48 months as a Squad Leader, Section Sergeant, NCOIC, Nutrition Care NCO

SFC: 24 to 36 months as a Detachment Sergeant, Platoon Sergeant, Chief Nutrition Care NCO

MSG: 18 to 36 months as a First Sergeant

CSM/SGM: N/A

Highly qualified looks like:

SSG: Nutrition Care NCO

SFC: Senior Nutrition Care NCO

MSG: Chief Nutrition Care NCO

CSM/SGM: N/A



MOS 68M

PHYSICAL FITNESS

Most-qualified looks like:

SSG: 540 ACFT score or above with 90 points in each event

SFC: 540 ACFT score or above with 90 points in each event

MSG: 540 ACFT score or above with 90 points in each event

CSM/SGM: N/A

Highly qualified looks like:

SSG: 480 ACFT score or above with 80 points in each event

SFC: 480 ACFT score or above with 80 points in each event

MSG: 480 ACFT score or above with 80 points in each event

MILITARY/CIVILIAN EDUCATION

Most-qualified looks like:

SSG: Exceeded ALC Course Standards, Leadership Award, Distinguished Honor/Honor Graduate, AA Degree

SFC: Exceeded SLC Course Standards, Leadership Award, Distinguished Honor/Honor Graduate, BS Degree

MSG: Exceeded MLC Course Standards, Leadership Award, Distinguished Honor Graduate, MS Degree

Highly qualified looks like:

SSG: Exceeded ALC Course Standards, Commandant's List, >60 college semester hours

SFC: Exceeded SLC Course Standards, Commandant's List, AA Degree

MSG: Exceeded MLC Course Standards, Commandant's List, >90 college semester hours towards BS



MOS 68M

ASSIGNMENTS (Broadening and Critical Leader Development) **PROPONENT SPECIFIC CHALLENGING / HIGH RISK**

SSG: Drill Sergeant, Holistic Health and Fitness NCO, Instructor Writer, Recruiter, Small Group Leader, SRU Squad Leader, **NCOIC, Operations NCO, Section/Squad Leader**

SFC: Attaché, Equal Opportunity Advisor, Inspector General NCO, Observer Coach/Trainer, Recruiter, Senior Drill Sergeant, Senior Drill Sergeant Leader, SHARP Master Advocate, SARC, Senior Instructor Writer, Senior Training Developer Writer, Senior Small Group Leader, SRU Platoon Sergeant, **Detachment Sergeant, Operations NCO, NCOIC, Platoon Sergeant**

MSG: Attaché, Chief Instructor Writer, Chief Training Developer Writer, Equal Opportunity Advisor, Inspector General NCO, SHARP Master Advocate, SARC, **First Sergeant**

CSM/SGM: N/A



MOS 68M

TRAINING

Most-qualified looks like:

SSG: EFMB, Certified Dietary Manager, Certified Food Protection Professional (CDM-CFPP)

SFC: EFMB, Certified Dietary Manager, Certified Food Protection Professional (CDM-CFPP)

MSG: EFMB, Certified Dietary Manager, Certified Food Protection Professional (CDM-CFPP)

CSM/SGM: N/A

Highly qualified looks like:

SSG: Air Assault, Airborne, EOL, MFT, MRT, SHARP, P3T Leader

SFC: Air Assault, Airborne, Battle Staff, EOA, MFT, MRT, SHARP, P3T Leader

MSG: Air Assault, Airborne, Battle Staff, EOA, MFT, MRT, SHARP

CSM/SGM: N/A

OTHER INDICATORS

Most-qualified looks like:

SSG: Active Audie Murphy or SGT Morales Club Member, awarded MOVSM for volunteer service, Army Best Medic Competitor, NCO of the Quarter/Year (**all annotated on NCOER**)

SFC: Active Audie Murphy or SGT Morales Club Member, awarded MOVSM for volunteer service, Army Best Medic Competitor, NCO of the Quarter/Year (**all annotated on NCOER**)

MSG: Award of the Order of Military Medical Merit (Regimental Award), Other Regimental Awards (**annotated on NCOER**)



U.S. ARMY

MOS 68P Progression Chart

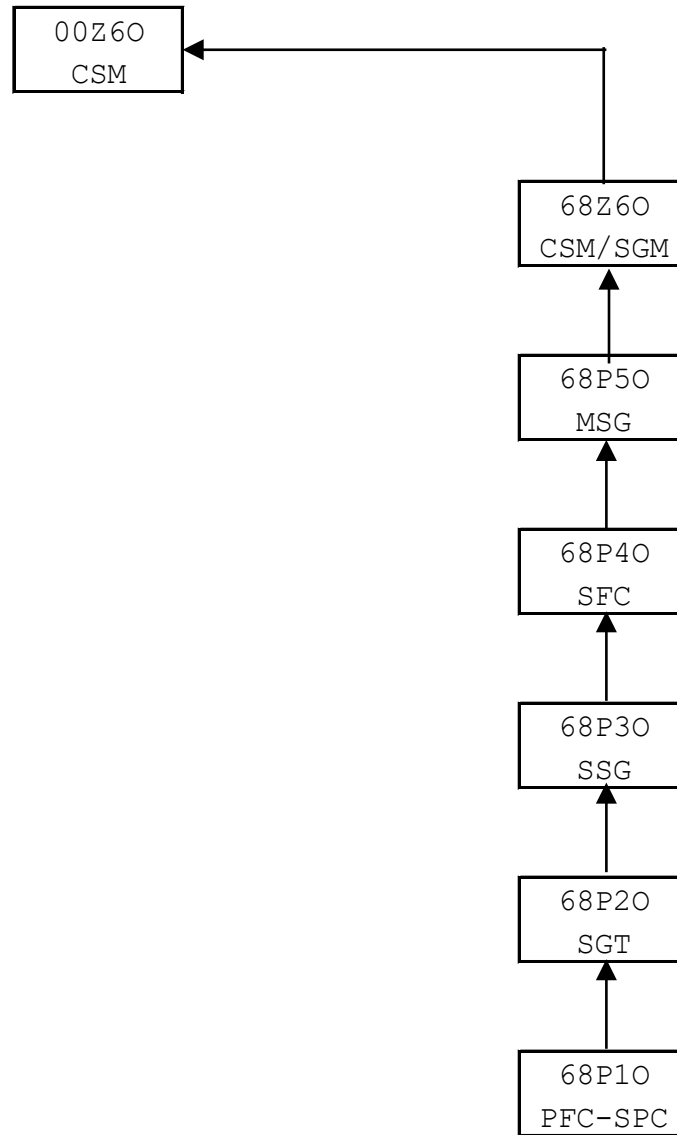



68P Talent Development Model

Years of Service	2	4	6	8	10	12	14	16	18	20	22	24	26	28
Rank														
Key Leadership Position	RADIOLOGY SPEC		RADIOLOGY SGT RADIOLOGY NCO		RADIOLOGY NCO SQUAD LEADER RECRUITER INSTRUCTOR INSTRUCTOR/WRITER		SR RADIOLOGY NCO DETACHMENT SERGEANT SR TRAINING DEVELOPER INSTRUCTOR INSTRUCTOR/WRITER		CH RADIOLOGY NCO CHIEF INSTRUCTOR FIRST SERGEANT					
Military/Civilian Education	DLC I BLC		DLC II ALC		DLC III SLC		DLC IV MLC		DLC V SMC					
	30 SEMESTER HOURS		ASSOCIATE DEGREE				BACHELOR'S DEGREE				AMERICAN REGISTRY OF TECHNOLOGISTS (ARRT): COMPUTED TOMOGRAPHY (CT), MAGNETIC RESONANCE IMAGING (MRI), RADIOGRAPHY (R), SONOGRAPHY (S)			
Critical Leadership Development					OPERATIONS NCO, NCOIC				FIRST SERGEANT					
					SECTION LEADER / SQUAD LEADER		DETACHMENT SERGEANT PLATOON SERGEANT							
Broadening Opportunities					RECRUITER									
					DRILL SERGEANT				SDS, SDS LEADER, SGL, SSSL, SRU PSG					
					INSTRUCTOR/WRITER, SGL, SOLDIER RECOVERY UNIT (SRU) SQUAD LEADER				ATTACHÉ, EOA, IG NCO, OC/T, SARC, SHARP MASTER ADVOCATE, CHIEF INSTRUCTOR/WRITER, CHIEF TRAINING DEVELOPER/WRITER, MEO INSTRUCTOR, SENIOR INSTRUCTOR/WRITER, SENIOR TRAINING DEVELOPER/WRITER					
Military Training	EXPERT FIELD MEDICAL BADGE, AIR ASSAULT, AIRBORNE, RANGER													
					EOL, UPL, MRT, MFT									
					BATTLE STAFF, P3T LEADER									



MOS 68P

The radiology specialist operates fixed and portable radiology equipment or supervises radiology activities. MOS 68P personnel require good eye-hand coordination and manual dexterity, no aversion to the sight of blood and be able to stand for long periods of time.

LEADERSHIP POSITIONS

Most-qualified looks like:

SSG: 24 to 48 months as a Squad Leader, Section Sergeant, NCOIC, Radiology NCO
SFC: 24 to 36 months as a Detachment Sergeant, Platoon Sergeant, Senior Radiology NCO
MSG: 18 to 36 months as a First Sergeant
CSM/SGM: N/A

Highly qualified looks like:

SSG: Radiology NCO
SFC: Senior Radiology NCO
MSG: Chief Radiology NCO
CSM/SGM: N/A



MOS 68P

PHYSICAL FITNESS

Most-qualified looks like:

SSG: 540 ACFT score or above with 90 points in each event

SFC: 540 ACFT score or above with 90 points in each event

MSG: 540 ACFT score or above with 90 points in each event

CSM/SGM: N/A

Highly qualified looks like:

SSG: 480 ACFT score or above with 80 points in each event

SFC: 480 ACFT score or above with 80 points in each event

MSG: 480 ACFT score or above with 80 points in each event

MILITARY/CIVILIAN EDUCATION

Most-qualified looks like:

SSG: Exceeded ALC Course Standards, Leadership Award, Distinguished Honor/Honor Graduate, AA Degree

SFC: Exceeded SLC Course Standards, Leadership Award, Distinguished Honor/Honor Graduate, BS Degree

MSG: Exceeded MLC Course Standards, Leadership Award, Distinguished Honor Graduate, MS Degree

Highly qualified looks like:

SSG: Exceeded ALC Course Standards, Commandant's List, >60 college semester hours

SFC: Exceeded SLC Course Standards, Commandant's List, AA Degree

MSG: Exceeded MLC Course Standards, Commandant's List, >90 college semester hours towards BS



MOS 68P

ASSIGNMENTS (Broadening and Critical Leader Development) **PROPONENT SPECIFIC CHALLENGING / HIGH RISK**

SSG: SSG: Drill Sergeant, Instructor Writer, Recruiter, Small Group Leader, SRU Squad Leader, NCOIC, Operations NCO, Section/Squad Leader

SFC: Attaché, Equal Opportunity Advisor, Inspector General NCO, Observer Coach/Trainer, Recruiter, Senior Drill Sergeant, Senior Drill Sergeant Leader, SHARP Master Advocate, SARC, Senior Instructor Writer, Senior Training Developer Writer, Senior Small Group Leader, SRU Platoon Sergeant, Detachment Sergeant, Operations NCO, NCOIC, Platoon Sergeant

MSG: Attaché, Chief Instructor Writer, Chief Training Developer Writer, Equal Opportunity Advisor, Inspector General NCO, SHARP Master Advocate, SARC, First Sergeant

CSM/SGM: N/A



MOS 68P

TRAINING

Most-qualified looks like:

SSG: EFMB, Radiography Certification (American Registry of Radiologic Technologists)

SFC: EFMB, Radiography Certification (American Registry of Radiologic Technologists)

MSG: EFMB, Radiography Certification (American Registry of Radiologic Technologists)

CSM/SGM: N/A

Highly qualified looks like:

SSG: Air Assault, Airborne, EOL, MFT, MRT, SHARP, P3T Leader

SFC: Air Assault, Airborne, Battle Staff, EOA, MFT, MRT, SHARP, P3T Leader

MSG: Air Assault, Airborne, Battle Staff, EOA, MFT, MRT, SHARP

OTHER INDICATORS

Most-qualified looks like:

SSG: Active Audie Murphy or SGT Morales Club Member, awarded MOVSM for volunteer service, Army Best Medic Competitor, NCO of the Quarter/Year (**all annotated on NCOER**)

SFC: Active Audie Murphy or SGT Morales Club Member, awarded MOVSM for volunteer service, Army Best Medic Competitor, NCO of the Quarter/Year (**all annotated on NCOER**)

MSG: Award of the Order of Military Medical Merit (Regimental Award), Other Regimental Awards (**annotated on NCOER**)



U.S. ARMY

MOS 68Q Progression Chart

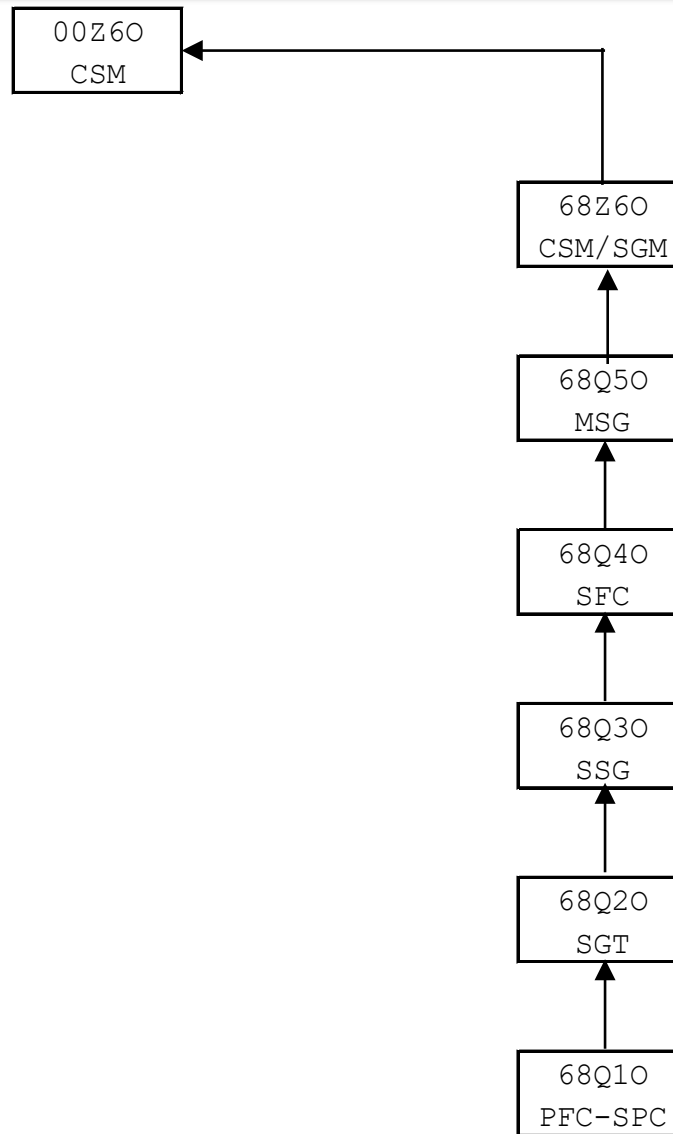



68Q Talent Development Model

Years of Service	2	4	6	8	10	12	14	16	18	20	22	24	26	28																				
Rank																																		
Key Leadership Position	PHARMACY SPEC		PHARMACY SGT		PHARMACY NCO MTTF PHARMACY OC/T RECRUITER INSTRUCTOR INSTRUCTOR/WRITER		PHARMACY NCO SR TRAINING DEVELOPER SGL INSTRUCTOR		SR PHARMACY NCO CHIEF INSTRUCTOR FIRST SERGEANT																									
Military/Civilian Education	DLC I BLC		DLC II ALC		DLC III SLC		DLC IV MLC		DLC V SMC		30 SEMESTER HOURS				ASSOCIATE DEGREE				BACHELOR'S DEGREE				PHARMACY TECHNICIAN CERTIFICATION BOARD-CERTIFIED PHARMACY TECHNICIAN (PTCB-CPHT)											
Critical Leadership Development					OPERATIONS NCO, NCOIC				SECTION LEADER / SQUAD LEADER				DETACHMENT SERGEANT PLATOON SERGEANT				FIRST SERGEANT																	
Broadening Opportunities			RECRUITER				DRILL SERGEANT				SDS, SDS LEADER, SGL, SSSL, SRU PSG				H2F NCO, SGL, INSTRUCTOR/WRITER, SOLDIER RECOVERY UNIT (SRU) SQUAD LEADER				ATTACHÉ, EOA, IG NCO, OC/T, SARC, SHARP MASTER ADVOCATE, CHIEF INSTRUCTOR/WRITER, CHIEF TRAINING DEVELOPER/WRITER, MEO INSTRUCTOR, SENIOR INSTRUCTOR/WRITER, SENIOR TRAINING DEVELOPER/WRITER															
Military Training	EXPERT FIELD MEDICAL BADGE, AIR ASSAULT, AIRBORNE, RANGER												EOL, UPL, MRT, MFT				BATTLE STAFF, P3T LEADER																	



MOS 68Q

The pharmacy specialist prepares, controls and issues pharmaceutical products under the supervision of a pharmacist or physician, and supervises pharmacy activities. MOS 68Q personnel require finger dexterity in both hands.

LEADERSHIP POSITIONS

Most-qualified looks like:

SSG: 24 to 48 months as a Squad Leader, Section Sergeant, NCOIC, Pharmacy NCO

SFC: 24 to 36 months as a Platoon Sergeant, Detachment Sergeant, Senior Pharmacy NCO

MSG: 18 to 36 months as a First Sergeant

CSM/SGM: N/A

Highly qualified looks like:

SSG: Pharmacy NCO

SFC: Senior Pharmacy NCO

MSG: Chief Pharmacy NCO

CSM/SGM: N/A



MOS 68Q

PHYSICAL FITNESS

Most-qualified looks like:

SSG: 540 ACFT score or above with 90 points in each event

SFC: 540 ACFT score or above with 90 points in each event

MSG: 540 ACFT score or above with 90 points in each event

CSM/SGM: N/A

Highly qualified looks like:

SSG: 480 ACFT score or above with 80 points in each event

SFC: 480 ACFT score or above with 80 points in each event

MSG: 480 ACFT score or above with 80 points in each event

MILITARY/CIVILIAN EDUCATION

Most-qualified looks like:

SSG: Exceeded ALC Course Standards, Leadership Award, Distinguished Honor/Honor Graduate, AA Degree

SFC: Exceeded SLC Course Standards, Leadership Award, Distinguished Honor/Honor Graduate, BS Degree

MSG: Exceeded MLC Course Standards, Leadership Award, Distinguished Honor Graduate, MS Degree

Highly qualified looks like:

SSG: Exceeded ALC Course Standards, Commandant's List, >60 college semester hours

SFC: Exceeded SLC Course Standards, Commandant's List, AA Degree

MSG: Exceeded MLC Course Standards, Commandant's List, >90 college semester hours towards BS Degree



MOS 68Q

ASSIGNMENTS (Broadening and Critical Leader Development)
PROPONENT SPECIFIC CHALLENGING / HIGH RISK

SSG: Drill Sergeant, Instructor Writer, Recruiter, Small Group Leader, SRU Squad Leader, **NCOIC, Operations NCO, Section/Squad Leader**

SFC: Attaché, Equal Opportunity Advisor, Inspector General NCO, Observer Coach/Trainer, Recruiter, Senior Drill Sergeant, Senior Drill Sergeant Leader, SHARP Master Advocate, SARC, Senior Instructor Writer, Senior Training Developer Writer, Senior Small Group Leader, SRU Platoon Sergeant, **Detachment Sergeant, Operations NCO, NCOIC, Platoon Sergeant**

MSG: Attaché, Chief Instructor Writer, Chief Training Developer Writer, Equal Opportunity Advisor, Inspector General NCO, SHARP Master Advocate, SARC, **First Sergeant**

CSM/SGM: N/A



MOS 68Q

TRAINING

Most-qualified looks like:

SSG: EFMB, PTCB-Certified Pharmacy Technician (PTCB-CPhT)

SFC: EFMB, PTCB-Certified Pharmacy Technician (PTCB-CPhT)

MSG: EFMB, PTCB-Certified Pharmacy Technician (PTCB-CPhT)

CSM/SGM: N/A

Highly qualified looks like:

SSG: Air Assault, Airborne, EOL, MFT, MRT, SHARP, P3T Leader

SFC: Air Assault, Airborne, Battle Staff, EOA, MFT, MRT, SHARP, P3T Leader

MSG: Air Assault, Airborne, Battle Staff, EOA, MFT, MRT, SHARP

CSM/SGM: N/A

OTHER INDICATORS

Most-qualified looks like:

SSG: Active Audie Murphy or SGT Morales Club Member, awarded MOVSM for volunteer service, Army Best Medic Competitor, NCO of the Quarter/Year **(all annotated on NCOER)**

SFC: Active Audie Murphy or SGT Morales Club Member, awarded MOVSM for volunteer service, Army Best Medic Competitor, NCO of the Quarter/Year **(all annotated on NCOER)**

MSG: Award of the Order of Military Medical Merit (Regimental Award), Other Regimental Awards **(annotated on NCOER)**



U.S. ARMY

MOS 68R Progression Chart

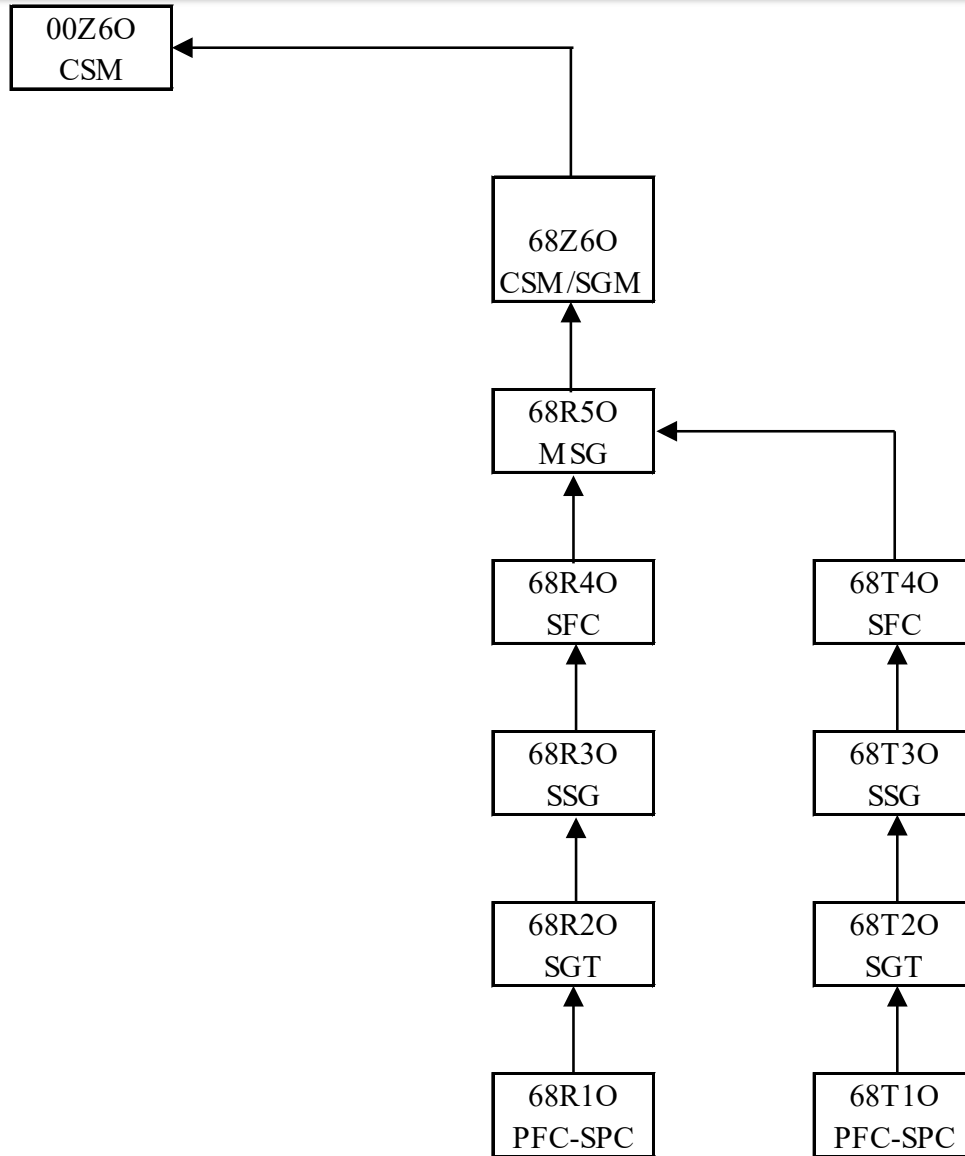



68R Talent Development Model

Years of Service	2	4	6	8	10	12	14	16	18	20	22	24	26	28
Rank														
Key Leadership Position	FOOD INSPECTOR		FOOD INSPECTION SGT		FOOD INSPECTION NCO INSTRUCTOR/WRITER INSTRUCTOR DRILL SERGEANT RECRUITER		SR FOOD INSP NCO SR TRAINING DEV/WRITER VET SVC NCO DETACHMENT SERGEANT PLATOON SERGEANT VICTIM ADVOCATE INSTRUCTOR, INSTRUCTOR/WRITER		CH VETERINARY NCO SR VETERINARY NCO VETERINARY SERVICE NCO CHIEF INSTRUCTOR FIRST SERGEANT					
Military/Civilian Education	DLC I BLC 30 SEMESTER HOURS		DLC II ALC ASSOCIATE DEGREE		DLC III SLC ASSOCIATE DEGREE		DLC IV MLC ASSOCIATE DEGREE		DLC V SMC BACHELOR'S DEGREE		BACHELOR'S DEGREE			
	SERVE SAFE FOOD MANAGER, CERTIFIED IN COMPREHENSIVE FOOD SAFETY (CCFS), FOOD SAFETY AND QUALITY AUDITOR CERTIFICATION (CFSQA)													
Critical Leadership Development					OPERATIONS NCO, NCOIC				FIRST SERGEANT					
					SECTION LEADER / SQUAD LEADER		DETACHMENT SERGEANT PLATOON SERGEANT							
Broadening Opportunities			RECRUITER				DRILL SERGEANT		SDS, SDS LEADER, SGL, SSGL, SRU PSG					
					INSTRUCTOR/WRITER, SGL, SOLDIER RECOVERY UNIT (SRU) SQUAD LEADER		ATTACHÉ, EOA, IG NCO, OC/T, SARC, SHARP MASTER ADVOCATE, CHIEF INSTRUCTOR/WRITER, CHIEF TRAINING DEVELOPER/WRITER, MEO INSTRUCTOR, SENIOR INSTRUCTOR/WRITER, SENIOR TRAINING DEVELOPER/WRITER							
Military Training	INSTALLATION VETERINARY SERVICES COURSE, EXPERT FIELD MEDICAL BADGE, AIR ASSAULT, AIRBORNE, RANGER													
	ADVANCED FOOD TECHNOLOGY COURSE				BATTLE STAFF, P3T LEADER									
	INSTALLATION FOOD VULNERABILITY ASSESSMENT COURSE													
	EOL, UPL, MRT, MFT													



MOS 68R

The Veterinary Food Inspection Specialist supervises the inspection of, or inspects meat, poultry, water foods, eggs, dairy products, operational rations, fresh fruits and vegetables in depots, supply points, and on military installations to assure a safe, high quality food supply for DoD personnel in all environments with emphasis on the field wartime environment.

LEADERSHIP POSITIONS

Most-qualified looks like:

SSG: 18 to 24 months as a Squad Leader, Section Sergeant, NCOIC, Veterinary Service NCO, Food Inspection NCO

SFC: 18 to 36 months as a Platoon Sergeant, Detachment Sergeant, Senior Veterinary NCO

MSG: 18 to 36 months as a First Sergeant

CSM/SGM: N/A

Highly qualified looks like:

SSG: Veterinary Service NCO

SFC: Senior Veterinary Service NCO

MSG: Chief Veterinary NCO

CSM/SGM: N/A



MOS 68R

PHYSICAL FITNESS

Most-qualified looks like:

SSG: 540 ACFT score or above with 90 points in each event

SFC: 540 ACFT score or above with 90 points in each event

MSG: 540 ACFT score or above with 90 points in each event

CSM/SGM: N/A

Highly qualified looks like:

SSG: 480 ACFT score or above with 80 points in each event

SFC: 480 ACFT score or above with 80 points in each event

MSG: 480 ACFT score or above with 80 points in each event

MILITARY/CIVILIAN EDUCATION

Most-qualified looks like:

SSG: Exceeded ALC Course Standards, Leadership Award, Distinguished Honor/Honor Graduate, AA Degree

SFC: Exceeded SLC Course Standards, Leadership Award, Distinguished Honor/Honor Graduate, BS Degree

MSG: Exceeded MLC Course Standards, Leadership Award, Distinguished Honor Graduate, MS Degree

Highly qualified looks like:

SSG: Exceeded ALC Course Standards, Commandant's List, >60 college semester hours

SFC: Exceeded SLC Course Standards, Commandant's List, AA Degree

MSG: Exceeded MLC Course Standards, Commandant's List, >90 college semester hours towards BS



MOS 68R

ASSIGNMENTS (Broadening and Critical Leader Development) **PROPONENT SPECIFIC CHALLENGING / HIGH RISK**

SSG: Drill Sergeant, Instructor Writer, Recruiter, Small Group Leader, SRU Squad Leader, **NCOIC, Operations NCO, Section/Squad Leader**

SFC: Attaché, Equal Opportunity Advisor, Inspector General NCO, Observer Coach/Trainer, Recruiter, Senior Drill Sergeant, Senior Drill Sergeant Leader, SHARP Master Advocate, SARC, Senior Instructor Writer, Senior Training Developer Writer, Senior Small Group Leader, SRU Platoon Sergeant, **Detachment Sergeant, Operations NCO, NCOIC, Platoon Sergeant**

MSG: Attaché, Chief Instructor Writer, Chief Training Developer Writer, Equal Opportunity Advisor, Inspector General NCO, SHARP Master Advocate, SARC, **First Sergeant**

CSM/SGM: N/A



MOS 68R

TRAINING

Most-qualified looks like:

SSG: EFMB, Certified Professional – Food Safety (CP-FS)

SFC: EFMB, Certified Professional – Food Safety (CP-FS)

MSG: EFMB, Certified Professional – Food Safety (CP-FS)

CSM/SGM: N/A

Highly qualified looks like:

SSG: Air Assault, Airborne, EOL, MFT, MRT, SHARP, P3T Leader

SFC: Air Assault, Airborne, MRT, SHARP, EOL, MFT

MSG: Air Assault, Airborne, MRT , MFT

CSM/SGM: N/A

OTHER INDICATORS

Most-qualified looks like:

SSG: Active Audie Murphy or SGT Morales Club Member, awarded MOVSM for volunteer service, Army Best Medic Competitor, NCO of the Quarter/Year **(all annotated on NCOER)**

SFC: Active Audie Murphy or SGT Morales Club Member, awarded MOVSM for volunteer service, Army Best Medic Competitor, NCO of the Quarter/Year **(all annotated on NCOER)**

MSG: Award of the Order of Military Medical Merit (Regimental Award), Other Regimental Awards **(annotated on NCOER)**



U.S. ARMY

MOS 68S Progression Chart

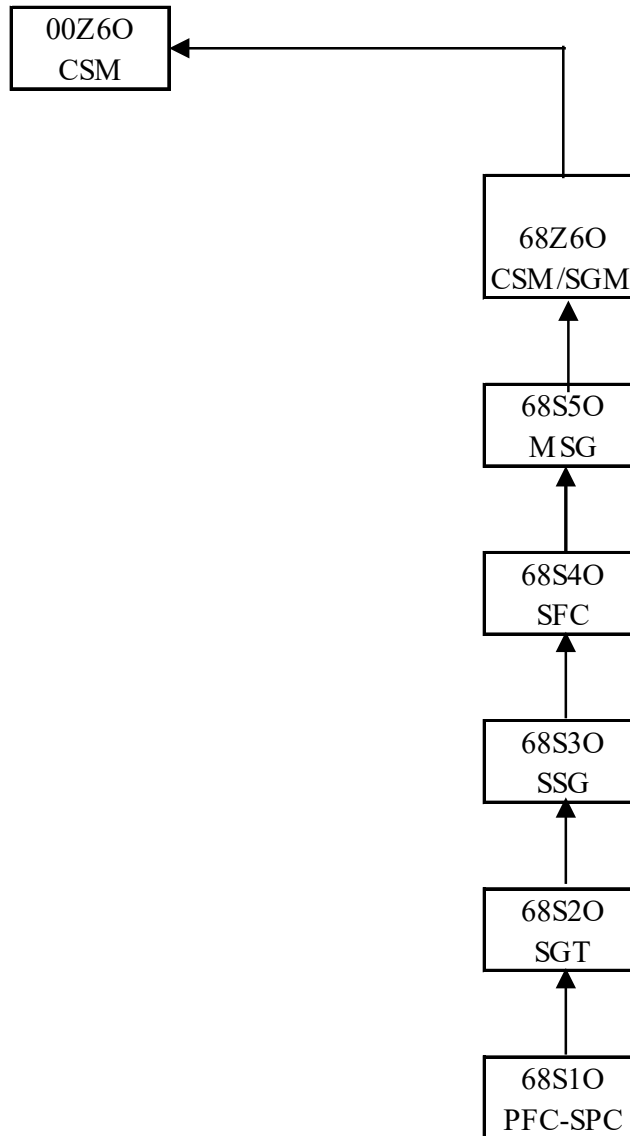



68S Talent Development Model

Years of Service	2	4	6	8	10	12	14	16	18	20	22	24	26	28
Rank														
Key Leadership Position	PREV MED SPEC N4-HEALTH PHYSICS SPEC		PREV MED NCO N4-HEALTH PHYSICS NCO		PREV MED NCO N4-HEALTH PHYSICS NCO INSTRUCTOR RECRUITER DRILL SERGEANT		PREV MED NCO N4-HEALTH PHYSICS NCO SR CRS MGT NCO INSTRUCTOR SR TRAINING DEV/WRITER CAMS CRS MGT NCO/INSTR DETACHMENT SERGEANT INSTRUCTOR		PREV MED NCO FIRST SERGEANT INSTRUCTOR					
Military/Civilian Education	DLC I BLC		DLC II ALC		DLC III SLC		DLC IV MLC		DLC V SMC		30 SEMESTER HOURS ASSOCIATE DEGREE BACHELOR'S DEGREE ASSOCIATE- INFECTION PREVENTION AND CONTROL (A-PIC), REGISTERED ENVIRONMENTAL HEALTH SPECIALIST/REGISTERED SANITARIAN (REHS/RS)			
Critical Leadership Development					OPERATIONS NCO, NCOIC				FIRST SERGEANT					
					SECTION LEADER / SQUAD LEADER		DETACHMENT SERGEANT PLATOON SERGEANT							
Broadening Opportunities			RECRUITER		DRILL SERGEANT		SDS, SDS LEADER, SGL, SSSL, SRU PSG		INSTRUCTOR/WRITER, SGL, SOLDIER RECOVERY UNIT (SRU) SQUAD LEADER ATTACHÉ, EOA, IG NCO, OC/T, SARC, SHARP MASTER ADVOCATE, CHIEF INSTRUCTOR/WRITER, CHIEF TRAINING DEVELOPER/WRITER, MEO INSTRUCTOR, SENIOR INSTRUCTOR/WRITER, SENIOR TRAINING DEVELOPER/WRITER					
Military Training	EXPERT FIELD MEDICAL BADGE, AIR ASSAULT, AIRBORNE, RANGER													
	EOL, UPL, MRT, MFT													
	BATTLE STAFF, P3T LEADER													
	N4-HEALTH PHYSICS													



MOS 68S

The Preventive Medicine Specialist conducts or assists with preventive medicine inspections, surveys, control operations and preventive medicine laboratory procedures, supervises preventive medicine facilities, or serves on preventive medicine staff.

LEADERSHIP POSITIONS

Most-qualified looks like:

SSG: 2 to 8 as a Platoon Sergeant, Preventive Med NCO, Health Physics NCO

SFC: 18 to 36 months as a Platoon Sergeant, Detachment Sergeant, Senior Preventive Med NCO

MSG: 18 to 36 months as a First Sergeant

CSM/SGM: N/A

Highly qualified looks like:

SSG: Preventive Med NCO, Health Physics NCO

SFC: Senior Preventive Med NCO

MSG: Chief Preventive Med NCO

CSM/SGM: N/A



MOS 68R

PHYSICAL FITNESS

Most-qualified looks like:

SSG: 540 ACFT score or above with 90 points in each event

SFC: 540 ACFT score or above with 90 points in each event

MSG: 540 ACFT score or above with 90 points in each event

CSM/SGM: N/A

Highly qualified looks like:

SSG: 480 ACFT score or above with 80 points in each event

SFC: 480 ACFT score or above with 80 points in each event

MSG: 480 ACFT score or above with 80 points in each event

MILITARY/CIVILIAN EDUCATION

Most-qualified looks like:

SSG: Exceeded ALC Course Standards, Leadership Award, Distinguished Honor/Honor Graduate, AA Degree

SFC: Exceeded SLC Course Standards, Leadership Award, Distinguished Honor/Honor Graduate, BS Degree

MSG: Exceeded MLC Course Standards, Leadership Award, Distinguished Honor Graduate, MS Degree

Highly qualified looks like:

SSG: Exceeded ALC Course Standards, Commandant's List, >60 college semester hours

SFC: Exceeded SLC Course Standards, Commandant's List, AA Degree

MSG: Exceeded MLC Course Standards, Commandant's List, >90 college semester hours towards BS Degree



MOS 68R

ASSIGNMENTS (Broadening and Critical Leader Development)
PROPONENT SPECIFIC CHALLENGING / HIGH RISK

SSG: Drill Sergeant, Instructor Writer, Recruiter, Small Group Leader, SRU Squad Leader, NCOIC, Operations NCO, Section/Squad Leader

SFC: Attaché, Equal Opportunity Advisor, Inspector General NCO, Observer Coach/Trainer, Recruiter, Senior Drill Sergeant, Senior Drill Sergeant Leader, SHARP Master Advocate, SARC, Senior Instructor Writer, Senior Training Developer Writer, Senior Small Group Leader, SRU Platoon Sergeant, Detachment Sergeant, Operations NCO, NCOIC, Platoon Sergeant

MSG: Attaché, Chief Instructor Writer, Chief Training Developer Writer, Equal Opportunity Advisor, Inspector General NCO, SHARP Master Advocate, SARC, First Sergeant

CSM/SGM: N/A



MOS 68R

TRAINING

Most-qualified looks like:

SSG: EFMB, Registered Environmental Health Specialist
SFC: EFMB, Registered Environmental Health Specialist
MSG: EFMB, Registered Environmental Health Specialist
CSM/SGM: N/A

Highly qualified looks like:

SSG: Air Assault, Airborne, EOL, MFT, MRT, SHARP, P3T Leader
SFC: Air Assault, Airborne, Battle Staff, EOA, MFT, MRT, SHARP, P3T Leader
MSG: Air Assault, Airborne, Battle Staff, EOA, MFT, MRT, SHARP
CSM/SGM: N/A

OTHER INDICATORS

Most-qualified looks like:

SSG: Active Audie Murphy or SGT Morales Club Member, awarded MOVSM for volunteer service, Army Best Medic Competitor, NCO of the Quarter/Year **(all annotated on NCOER)**

SFC: Active Audie Murphy or SGT Morales Club Member, awarded MOVSM for volunteer service, Army Best Medic Competitor, NCO of the Quarter/Year **(all annotated on NCOER)**

MSG: Award of the Order of Military Medical Merit (Regimental Award), Other Regimental Awards **(annotated on NCOER)**



U.S. ARMY

MOS 68T Progression Chart

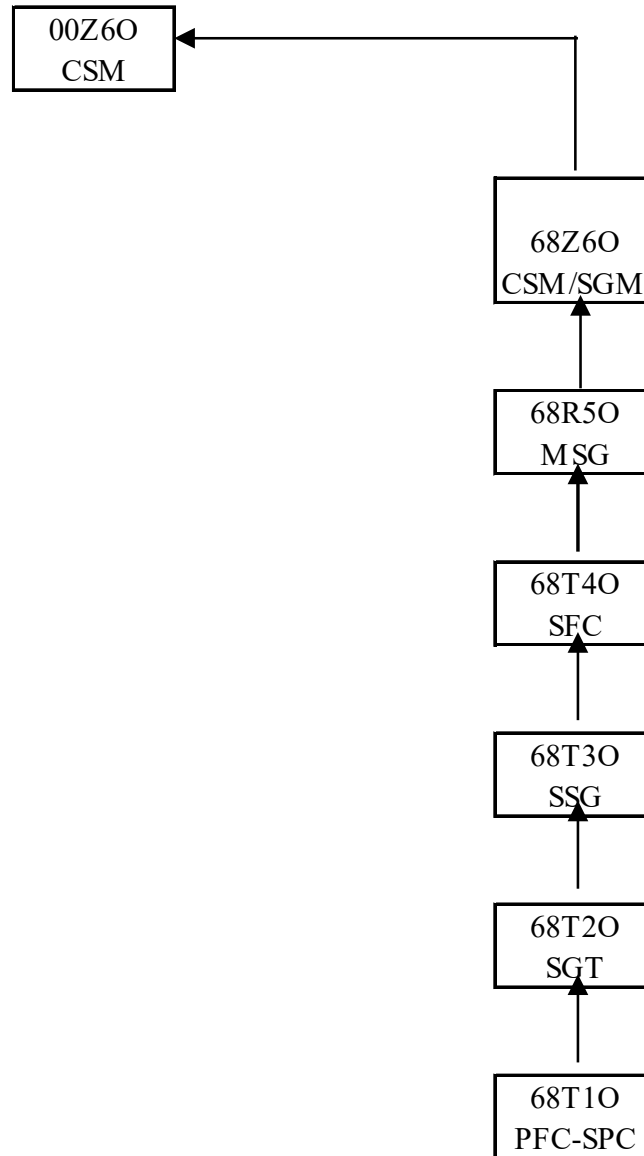



U.S. ARMY

68T Talent Development Model (Merges into 68R at E8/MSG)

Years of Service	2	4	6	8	10	12	14	16	18	20	22	24	26	28
Rank														
Key Leadership Position	ANIMAL CARE SPEC LAB ANIMAL TECH		ANIMAL CARE NCO LAB ANIMAL TECH ANIMAL CARE SGT		ANIMAL CARE NCO VETERINARY OPS NCO AMEDD RCTG NCO RECRUITER SR INSTRUCTOR/WRITER INSTRUCTOR			SR ANIMAL CARE NCO CH VET SVC NCO VETERINARY OPS NCO DETACHMENT SERGEANT SR TRAINING DEV/WRITER INSTRUCTOR INSTRUCTOR/WRITER						
Military/Civilian Education	DLC I BLC 30 SEMESTER HOURS		DLC II ALC ASSOCIATE DEGREE		DLC III SLC			DLC IV MLC ASSOCIATE DEGREE AMERICAN ASSOCIATION OF VETERINARY STATE BOARDS (AAVSB), VETERINARY TECHNICIAN NATIONAL EXAM (VTNE)						
Critical Leadership Development					OPERATIONS NCO, NCOIC SECTION LEADER / SQUAD LEADER DETACHMENT SERGEANT PLATOON SERGEANT									
Broadening Opportunities			RECRUITER DRILL SERGEANT			INSTRUCTOR/WRITER, SGL, SOLDIER RECOVERY UNIT (SRU) SQUAD LEADER SDS, SDS LEADER, SGL, SSGL, SRU PSG, OC/T, ATTACHÉ, EOA, MEO INSTRUCTOR, IG NCO, SARC, SHARP MASTER ADVOCATE, CHIEF INSTRUCTOR/WRITER, CHIEF TRAINING DEVELOPER/WRITER, SENIOR INSTRUCTOR/WRITER, SENIOR TRAINING DEVELOPER/WRITER								
Military Training	EXPERT FIELD MEDICAL BADGE, AIR ASSAULT, AIRBORNE, RANGER													
							EOL, UPL, MRT, MFT							
					BATTLE STAFF, P3T LEADER									



MOS 68T

The Animal Care Specialist supervises or provides the care, management, treatment, and sanitary conditions for animals, with a primary responsibility of prevention and control of diseases transmitted from animal to man and comprehensive care for government owned animals.

LEADERSHIP POSITIONS

Most-qualified looks like:

SSG: 24 to 36 as a Platoon Sergeant, Animal Care NCO, Veterinary Ops NCO

SFC: 18 to 36 months as a Platoon Sergeant, Detachment Sergeant

MSG: N/A

Highly qualified looks like:

SSG: Animal Care NCO, Veterinary Ops NCO

SFC: Senior Animal Care NCO, Senior Veterinary Ops NCO

MSG: N/A



MOS 68T

PHYSICAL FITNESS

Most-qualified looks like:

SSG: 540 ACFT score or above with 90 points in each event

SFC: 540 ACFT score or above with 90 points in each event

MSG: N/A

Highly qualified looks like:

SSG: 480 ACFT score or above with 80 points in each event

SFC: 480 ACFT score or above with 80 points in each event

MSG: N/A

MILITARY/CIVILIAN EDUCATION

Most-qualified looks like:

SSG: Exceeded ALC Course Standards, Leadership Award, Distinguished Honor/Honor Graduate, AA Degree

SFC: Exceeded SLC Course Standards, Leadership Award, Distinguished Honor/Honor Graduate, BS Degree

MSG: N/A

Highly qualified looks like:

SSG: Exceeded ALC Course Standards, Commandant's List, >60 college semester hours

SFC: Exceeded SLC Course Standards, Commandant's List, AA Degree

MSG: N/A



MOS 68T

ASSIGNMENTS (Broadening and Critical Leader Development)
PROPONENT SPECIFIC CHALLENGING / HIGH RISK

SSG: Drill Sergeant, Instructor Writer, Recruiter, Small Group Leader, SRU Squad Leader, NCOIC, Operations NCO, Section/Squad Leader

SFC: Attaché, Equal Opportunity Advisor, Inspector General NCO, Observer Coach/Trainer, Recruiter, Senior Drill Sergeant, Senior Drill Sergeant Leader, SHARP Master Advocate, SARC, Senior Instructor Writer, Senior Training Developer Writer, Senior Small Group Leader, SRU Platoon Sergeant, Detachment Sergeant, Operations NCO, NCOIC, Platoon Sergeant

MSG: N/A



MOS 68T

TRAINING

Most-qualified looks like:

SSG: EFMB, Assistant Laboratory Animal Technician (ALAT) Certification

SFC: EFMB, Assistant Laboratory Animal Technician (ALAT) Certification

MSG: N/A

Highly qualified looks like:

SSG: Air Assault, Airborne, EOL, MFT, MRT, SHARP, P3T Leader

SFC: Air Assault, Airborne, Battle Staff, EOA, MFT, MRT, SHARP, P3T Leader

MSG: N/A

OTHER INDICATORS

Most-qualified looks like:

SSG: Active Audie Murphy or SGT Morales Club Member, awarded MOVSM for volunteer service, Army Best Medic Competitor, NCO of the Quarter/Year (**all annotated on NCOER**)

SFC: Active Audie Murphy or SGT Morales Club Member, awarded MOVSM for volunteer service, Army Best Medic Competitor, NCO of the Quarter/Year (**all annotated on NCOER**)

MSG: N/A



U.S. ARMY

MOS 68V Progression Chart

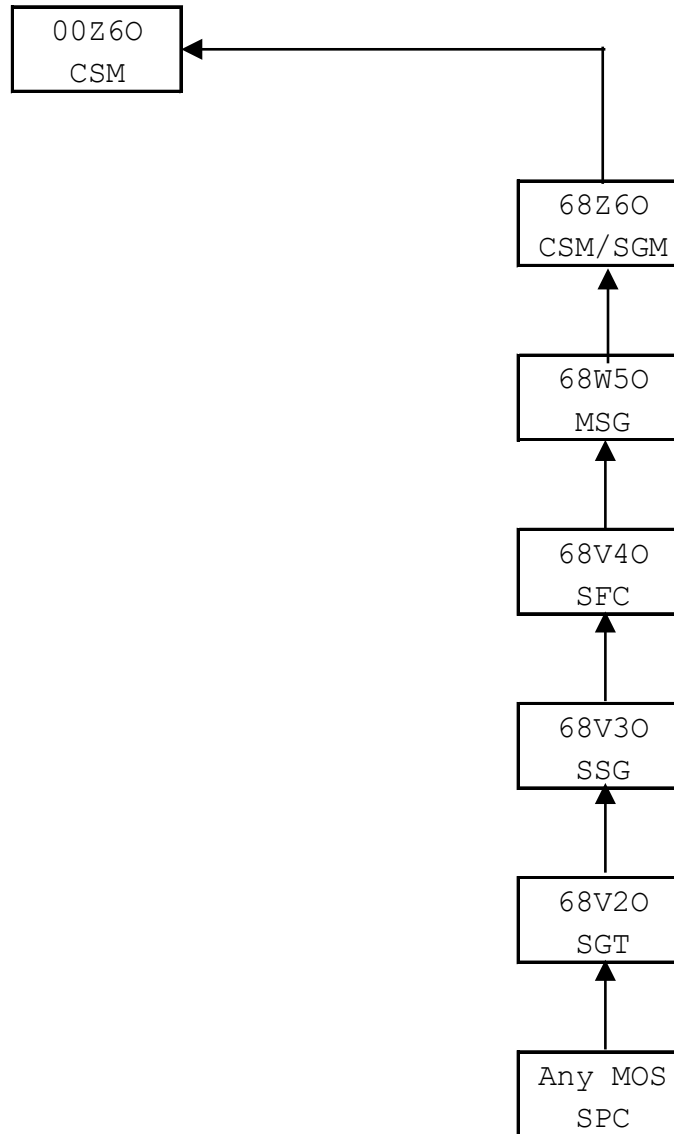



MOS 68V

The respiratory specialist assists the physician in the care, examination and treatment of acute and chronic diseases of the respiratory and cardiac region or assists with the management of the respiratory care areas at both the general and intensive care areas.

LEADERSHIP POSITIONS

Most-qualified looks like:

SSG: 24 to 48 months as a Squad Leader, Section Sergeant, NCOIC, Respiratory NCO

SFC: 18 to 36 months as a Detachment Sergeant, Platoon Sergeant

MSG: N/A

Highly qualified looks like:

SSG: Respiratory NCO

SFC: Senior Respiratory NCO

MSG: N/A



MOS 68V

PHYSICAL FITNESS

Most-qualified looks like:

SSG: 540 ACFT score or above with 90 points in each event

SFC: 540 ACFT score or above with 90 points in each event

MSG: N/A

Highly qualified looks like:

SSG: 480 ACFT score or above with 80 points in each event

SFC: 480 ACFT score or above with 80 points in each event

MSG: N/A

MILITARY/CIVILIAN EDUCATION

Most-qualified looks like:

SSG: Exceeded ALC Course Standards, Leadership Award, Distinguished Honor/Honor Graduate, BS Degree

SFC: Exceeded SLC Course Standards, Leadership Award, Distinguished Honor/Honor Graduate, BS Degree

MSG: N/A

Highly qualified looks like:

SSG: Exceeded ALC Course Standards, Commandant's List, AA Degree

SFC: Exceeded SLC Course Standards, Commandant's List, >90 college semester hours towards BS

MSG: N/A



MOS 68V

ASSIGNMENTS (Broadening and Critical Leader Development)
PROPONENT SPECIFIC CHALLENGING / HIGH RISK

SSG: Drill Sergeant, Instructor Writer, Recruiter, Small Group Leader, SRU Squad Leader, NCOIC, Operations NCO, Section/Squad Leader

SFC: Attaché, Equal Opportunity Advisor, Inspector General NCO, Observer Coach/Trainer, Recruiter, Senior Drill Sergeant, Senior Drill Sergeant Leader, SHARP Master Advocate, SARC, Senior Instructor Writer, Senior Training Developer Writer, Senior Small Group Leader, SRU Platoon Sergeant, Detachment Sergeant, Operations NCO, NCOIC, Platoon Sergeant

MSG: N/A



MOS 68V

TRAINING

Most-qualified looks like:

SSG: EFMB, Registered Respiratory Therapist (RRT)

SFC: EFMB, Registered Respiratory Therapist (RRT)

MSG: N/A

Highly qualified looks like:

SSG: Air Assault, Airborne, EOL, MFT, MRT, SHARP, P3T Leader

SFC: Air Assault, Airborne, Battle Staff, EOA, MFT, MRT, SHARP, P3T Leader

MSG: N/A

OTHER INDICATORS

Most-qualified looks like:

SSG: Active Audie Murphy or SGT Morales Club Member, awarded MOVSM for volunteer service, Army Best Medic Competitor, NCO of the Quarter/Year **(all annotated on NCOER)**

SFC: Active Audie Murphy or SGT Morales Club Member, awarded MOVSM for volunteer service, Army Best Medic Competitor, NCO of the Quarter/Year **(all annotated on NCOER)**

MSG: N/A



U.S. ARMY

MOS 68W Progression Chart

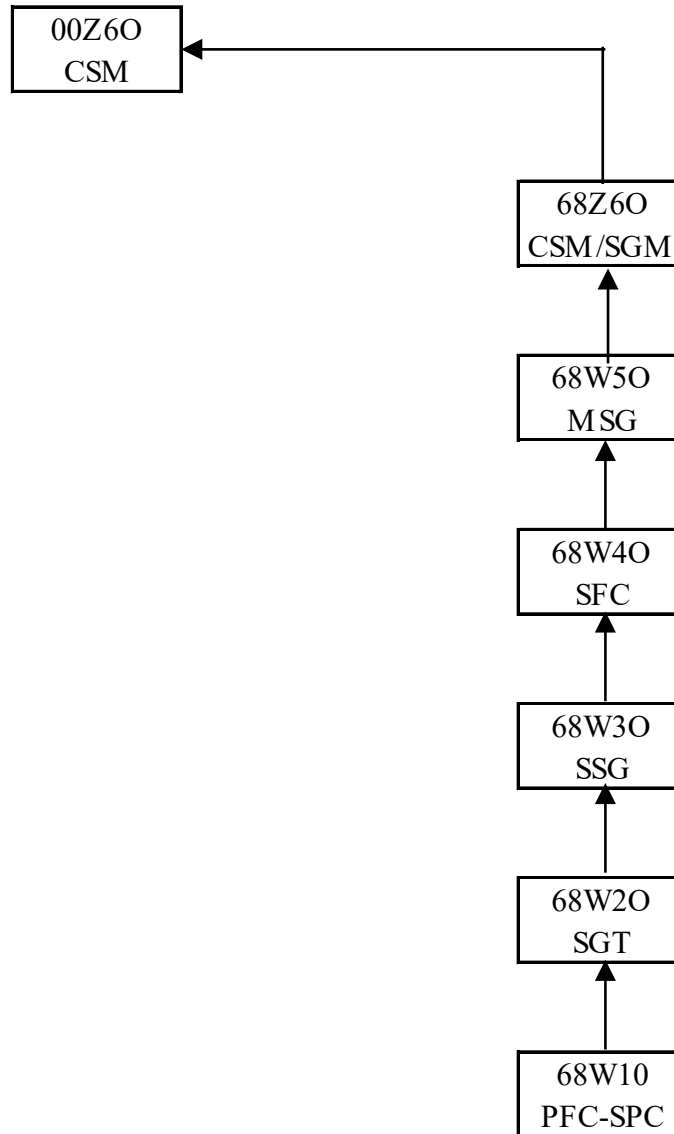



U.S. ARMY

68W Talent Development Model

Years of Service

2 4 6 8 10 12 14 16 18 20 22 24 26 28

Rank										
Key Leadership Position	AMB AIDE/DRIVER CA TRAUMA MED SPEC COMBAT MEDIC SPEC EMERG CARE SPEC FLIGHT MEDIC HEALTHCARE SPEC IMM/ALLERGY SPEC LITTLER BEARER VEHICLE DRIVER	CA TRAUMA MED SGT EMERG MED CARE SGT EMERG MED CARE NCOIC FLIGHT PARAMEDIC NCO FLIGHT MEDIC HEALTH CARE SGT IMM/ALLERGY NCO INSTRUCTOR MED ADVISOR MED OPS NCO MED READINESS NCO PT MVMT CLIN OPS	AIR AMB NCO, EMERG MEDCARE NCO, EXEC ASST (CSM), FAA MEDIC OC/T, FIELD CRAFT NCOIC, FLD MEDIC INSTR, FLIGHT MEDIC INSTR, FLT PARAMEDIC NCO, HEALTHCARE NCO, HEALTHCARE SGT/TP, IMM/ALLERGY NCO, INSTR/TRAINER, INSTR/WRITER, JROTC- MED INSTR, MEDOPS NCO, OPS NCO, MEDPLANS NCO, MEDTRNG NCO, MEDIC, MEDICAL NCOIC, SECTION NCO, SQD LDR, ENL LDR/INSTR, VICTIM ADVOCATE, WHMU HEALTHCARE SPEC	ADVISOR, CA MED OPS NCO, DET SERGEANT, EMERG CARE NCO, EO ADV, EVAC OPS NCO, EVAC PLT PSG, AIR AMB DET 1SG, FLD CRAFT NCOIC, FLIGHT MEDIC INSTR, FLD MED SPEC, SR HEALTH CARE NCO, IG NCO, IMM/ALLERGY NCO, BASIC ABN RFRSHR INSTR, INTEL NCO, INSTR/WRITER, MEDICAL NCOIC, MED READ/PLAN/MOB NCO, MEDOPS NCO ADV, MEDPLANS NCO, MEDICAL SFA ASSESS NCO, SR MED INSTR, OPS NCO,(SEE CONT. SLIDE)	BDE SR MEDIC, CA MED OPS SGT CH INSTRUCTOR/WRITER, CHIEF INSTRUCTOR EO ADVISOR, MEO ADVISOR, FIRST SERGEANT, IG NCO, INTELLIGENCE MED NCO, LEADER DEV NCO, MEDICAL NCO, MED OPS NCO OPS NCO, PLANS NCO, SR ADVISOR, SR CAREER MGT NCO SR ENL MED ADVISOR, SR EVAC OPS NCO SR HEALTH CARE NCO, SR INSTRUCTOR/WRITER SR OPS NCO, SR TALENT MGT NCO SR TRNG DEV/WRITER, TRNG DEVELOPER BSB TXT NCO OC/T, MTTF SR CLINICAL OC/T MTTF SR MED NCO OC/T, SR MED NCO OC/T					
Military/Civilian Education	DLC I	DLC II	DLC III	DLC IV	DLC V	BLC				
	30 SEMESTER HOURS		ASSOCIATE DEGREE			BACHELOR'S DEGREE			SMC	
	ADVANCED EMERGENCY MEDICAL TECHNICIAN (A-EMT), NATIONALLY REGISTERED PARAMEDIC (NR-P)									
Critical Leadership Development	OPERATIONS NCO, NCOIC					SEE CLD SLIDE OR DA PAM 600-25, CH 21, 21-6D.		DETACHMENT SERGEANT PLATOON SERGEANT		FIRST SERGEANT
Broadening Opportunities	RECRUITER, INSTRUCTOR, INSTRUCTOR/WRITER					DRILL SERGEANT, SFAB,		SDS, SDS LEADER, SGL, SSSL, SFAB, SRU PSG		ATTACHÉ, EOA, IG NCO, OC/T (PROJECT WARRIOR), SARC, SHARP MASTER ADVOCATE, CHIEF INSTRUCTOR/WRITER, CHIEF TRAINING DEVELOPER/WRITER, MEO INSTRUCTOR, SENIOR INSTRUCTOR/WRITER, SENIOR TRAINING DEVELOPER/WRITER
	SGL, VICTIM ADVOCATE SOLDIER RECOVERY UNIT (SRU) SQUAD LEADER									
Military Training	F2-CRITICAL CARE FLIGHT PARAMEDIC, 3P-NATIONALLY REGISTERED PARAMEDIC, EXPERT FIELD MEDICAL BADGE, AIR ASSAULT, AIRBORNE, RANGER									
	W1-SPECIAL OPERATIONS COMBAT MEDIC (SOCM), Y8-IMMUNIZATION/ALLERGY									
	Q5-SF COMBAT DIVING, MEDICAL			BATTLE STAFF, P3T LEADER						
	MRT, MFT									
	6-MOBILIZATION & DEMOBILIZATION OPS, 6B-RECONNAISSANCE & SURVEILLANCE LEADERS COURSE, EOL, UPL									



U.S. ARMY

68W Talent Development Model continued

Years of Service	2	4	6	8	10	12	14	16	18	20	22	24	26	28
Rank														
Key Leadership Position	<p>OPS/TRNG NCO, PLT SERGEANT, PLANS NCO, PLANS/OPS/TRNG NCO, SAPR/SHARP ADVISOR, SARC, LSN LRND DEVELOPER, SHARP PGM MGR, SR CMD MEDIC, SR FLT MEDIC, SR INSTR, SR TRNG DEV/WRITER, SR TRNG MGR INSTR, SR TRNG MGT NCO, SSGI, SSGI/PSG, SGN CELL NCOIC, TALENT MGT NCO, TEST & EVAL NCO, TRNG DEV, WHMU CLINIC MGR,</p> <p>OC/T, AVN FLIGHT INSTR OC/T, AVN MEDEVAC OC/T, BDE FLIGHT MEDIC OC/T, BDE MED OPS NCO OC/T, BEB MED NCO OC/T, BEB MED OC/T, BN MED OC/T, BSB AMBULANCE NCO OC/T, BSB MED AMB PLT OC/T, BSB MED TM PLT OC/T, FABN MED NCO OC/T, FABN MED PLT OC/T, FABN MEDICAL NCO OC/T, FABN MEDICAL OC/T, FWD MED TM OC/T, INF BN MED PLT OC/T, MED CO EVAC PLT O/CT, MED CO SR NCO O/CT, MED CO TXT PLT O/CT, MED NCO OC/T, MED TRAINER OC/T, MEDICAL OC/T, MN MED PSG OC/T, MTTF SR CLINICAL OC/T, SQDN MED PLT OC/T, TF MED OC/T, TF MED PLT OC/T</p>													



68W CLD POSITIONS

UNIT TYPE	POSITION	TITLE	UNIT TYPE	POSITION	TITLE
75TH RANGER REGT	STB, AMB SQD	EMERGENCY CARE SGT	COMMUNITY HOSPITAL	ADULT OUTPNT NEURO	HEALTHCARE SGT
	AMB TM	EMERGENCY CARE SGT		CARDIOLOGY WD	HEALTHCARE SGT
	COMBAT MEDIC SECTION	EMERGENCY CARE SGT		ER/ED	HEALTHCARE SGT
	STB, COMBAT MEDIC SECTION	EMERGENCY CARE SGT		GEN OP/FAM PRAC	HEALTHCARE SGT
	STB, TXT SQD	EMERGENCY CARE SGT		HEM/ONC WARD	HEALTHCARE SGT
ADA REGT	TXT SQD	HEALTHCARE SGT		PRIMARY CARE CLINIC	HEALTHCARE SGT
	BN, MED TXT TM	HEALTHCARE SGT		UROLOGY	HEALTHCARE SGT
ARTB	BTRY HQ	HEALTHCARE SGT		ADMIN	HEALTHCARE SGT
	AIR AMB DET	AIR AMBULANCE NCO		ALLERGY	IMM/ALLERGY NCO
AREA SPT GRP	MED SPT SECTION	EMERGENCY MED CARE NCO		AMB SECTION	HEALTHCARE SGT
	SURGEON	PREV MED NCO		EKG	HEALTHCARE SGT
BCT	SURGEON	HEALTHCARE SGT		ER/ED	HEALTHCARE SGT
	AMB SQD	SECTION NCO		FAMILY MEDICINE	HEALTHCARE SGT
	AREA MED TXT	HEALTHCARE SGT		GENERAL PEDS	HEALTHCARE SGT
	CO HQ	SECTION NCO		GENERAL SURGERY	HEALTHCARE SGT
	COMBAT MEDIC SECTION	SECTION NCO	HQ CO	HEALTHCARE SGT	
	MED PLT HQ	SECTION NCO	IMMUNIZATION CLINIC	IMM/ALLERGY NCO	
	MED SECTION	HEALTHCARE SGT	INTERNAL MEDICINE	HEALTHCARE SGT	
	MED TM	HEALTHCARE SGT	MIXED MED/SUR/PEDS	HEALTHCARE SGT	
	MED TXT SECTION	HEALTHCARE SGT	MOTHER/BABY UNIT	HEALTHCARE SGT	
	MED TXT SQD	HEALTHCARE SGT	OB/GYN	HEALTHCARE SGT	
	MED TXT TM	HEALTHCARE SGT	OCC HLTH CLINIC	HEALTHCARE SGT	
	STB/MED TXT TM	HEALTHCARE SGT	PCU	HEALTHCARE SGT	
	SUSTAINMENT/MED	HEALTHCARE SGT	PEDS	HEALTHCARE SGT	
	CCP, ASCC	TXT SQD	HEALTHCARE SGT	PHYSICAL EXAMS	HEALTHCARE SGT
MED TXT SECTION		HEALTHCARE SGT	PODIATRY SVC	HEALTHCARE SGT	
CENTER OF EXCELLENCE	S2/S3 OPS	HEALTHCARE SGT	PRIMARY CARE CLINIC	HEALTHCARE SGT	
	CO HQ (AIT)	HEALTHCARE SPEC	PRIMARY CARE CLINIC	IMM/ALLERGY NCO	
	FIELD SPT PLT	HEALTHCARE SGT	PUB HLTH NSG	HEALTHCARE SGT	
	MED SPT UNIT	EMERGENCY CARE NCO	ACUTE CARE	HEALTHCARE SGT	
CHEM BDE, HHC	AIR AMB DET	AIR AMBULANCE NCO	ADOLESCENT MEDICINE	HEALTHCARE SGT	
	MED TXT TM	HEALTHCARE SGT	ALLERGY	IMM/ALLERGY NCO	
COMBAT AVN BDE	MED TXT SQD	HEALTHCARE SGT	ANESTHESIOLOGY	HEALTHCARE SGT	
	AIR AMB SECTION	FLIGHT PARAMEDIC NCO	APU/SDS/PACU	HEALTHCARE SGT	
	CO HQ	FLIGHT PARAMEDIC NCO	DERMATOLOGY	HEALTHCARE SGT	
	FWD SPT MEDEVAC	FLIGHT PARAMEDIC NCO	EKG	HEALTHCARE SGT	
	MED TXT SQD	HEALTHCARE SGT	ER/ED	HEALTHCARE SGT	
COMBAT AVN BDE (SPEC OPS)	MED TXT TM	HEALTHCARE SGT	FAMILY MEDICINE	HEALTHCARE SGT	
	SPT, BDE, AIR AMB SECTION	FLIGHT PARAMEDIC NCO	FAMILY MEDICINE	IMM/ALLERGY NCO	
CORPS, HHBN	SOA MED TXT TM	FLIGHT PARAMEDIC NCO	GASTROENTEROLOGY	HEALTHCARE SGT	
DIV, HHBN	MED TXT SECTION	HEALTHCARE SGT	GENERAL PEDS	HEALTHCARE SGT	
EIGHTH ARMY, HHBN	MED TXT SECTION	HEALTHCARE SGT	GENERAL SURGERY	HEALTHCARE SGT	
MI BDE, HHC	MED SECTION	HEALTHCARE SGT	HEM/ONC WARD	HEALTHCARE SGT	
MI BN,	MED SECTION	HEALTHCARE SGT	INTERNAL MEDICINE	HEALTHCARE SGT	
NWTC	MED TXT TM	HEALTHCARE SGT	NEURO SURGERY SVC	HEALTHCARE SGT	
PSY OPS GRP, HHC	OPS & SUPT BR	EMERGENCY CARE NCO	NEUROLOGY SVC	HEALTHCARE SGT	
SFAB	MED SECTION	HEALTHCARE SGT	OB/GYN	HEALTHCARE SGT	
SPECIAL FORCES GROUP	MED TM	HEALTHCARE SGT	OCC HLTH CLINIC	HEALTHCARE SGT	
SRU	CIVIL AFFAIRS SECTION	HEALTHCARE SGT	PATIENT TRANSPORTATION	HEALTHCARE SGT	
SUSTAINMENT BDE	TRANSITION SVCS CARE	SQUAD LEADER	PEDS	HEALTHCARE SGT	
	AMB DET RECVRY TM	HEALTHCARE SGT	PRIMARY CARE CLINIC	HEALTHCARE SGT	
US ACC	LEVEL I MED SECTION	HEALTHCARE SGT	PUB HLTH NSG	HEALTHCARE SGT	
	STB/MED TXT TM	HEALTHCARE SGT	RTF	HEALTHCARE SGT	
US ARMY ELEMENT USUHS	DISPENSARY	HEALTHCARE SGT	SURGERY ICU	HEALTHCARE SGT	
	DIR OF TXT PROG	HEALTHCARE SGT	UROLOGY	HEALTHCARE SGT	
US ARMY OTC	FAMILY PRACTICE DEPT	MEDIC	AREA SPT MED TM	HEALTHCARE SGT	
US TFS	ABN SOTD DIR STAFF	HEALTHCARE SGT/TP	EVAC SECTION	SECTION NCO	
USAFAS	BASE CLINIC	HEALTHCARE SGT	MED TXT SQD	HEALTHCARE SGT	
	MEDIC PLT	EMERGENCY MED CARE NCO	FIELD HOSPITAL	TRIAGE/PRE-OP/EMT SECT	
USAE, DHA RDA CENTER	BEHAVIORAL DEPT	HEALTHCARE SGT	USAOs	WTX CELL	
	DCS FOR OPS (G/5/7)	HEALTHCARE SGT	USARIEM	MED SPT BR	
	MEDICINE	HEALTHCARE SGT	USATC FT JACKSON	MED HR RANGE SPT	
	OPS	HEALTHCARE SGT	YPG	ABN TEST BR	
USAFAS	HQB (FA BDE)	EMERGENCY MED CARE NCO	YTC, AIR AMB DET	AIR AMB SECTION	
USAJFKSWCS	TRNG GRP HQs	HEALTHCARE SGT			



MOS 68W

The combat medic specialist provides emergency medical treatment, limited primary care, force health protection, evacuation in a variety of operational and clinical settings from point of injury or illness through the continuum of military health care and, as a field combat medic, provides emergency medical care/treatment at point of wounding on the battlefield or to battle and non-battle casualties during wartime.

LEADERSHIP POSITIONS

Most-qualified looks like:

SSG: 24 to 48 months as a Squad/Section Leader or NCOIC with MQ rating and high enumeration and selected to serve as a Platoon Sergeant.

SFC: 24 to 36 months as a Detachment Sergeant, Platoon Sergeant, Senior Health Care NCO

MSG: 24 to 36 months as a First Sergeant, Senior Advisor,

CSM/SGM: N/A

Highly qualified looks like:

SSG: Health Care Sergeant, Emergency Care Sergeant, Section NCO, Medical NCO, Flight Paramedic NCO

SFC: Platoon Sergeant, Detachment Sergeant, Clinic NCO, Health Care NCO, Emergency Care NCO, Operations Sergeant, Intelligence Sergeant, Plans Sergeant, Civil Affairs Medical Operations Sergeant, Immunology-Allergy NCO

MSG: First Sergeant, Senior Health Care NCO, Operations NCO, Intelligence Medical Sergeant, Plans NCO, Senior Advisor, Senior Civil Affairs Medical Sergeant, Civil Affairs Medical Operations Sergeant

CSM/SGM: N/A



MOS 68W

PHYSICAL FITNESS

Most-qualified looks like:

SSG: 540 ACFT score or above with 90 points in each event

SFC: 540 ACFT score or above with 90 points in each event

MSG: 540 ACFT score or above with 90 points in each event

CSM/SGM: N/A

Highly qualified looks like:

SSG: 480 ACFT score or above with 80 points in each event

SFC: 480 ACFT score or above with 80 points in each event

MSG: 480 ACFT score or above with 80 points in each event

CSM/SGM: N/A

MILITARY/CIVILIAN EDUCATION

Most-qualified looks like:

SSG: Exceeded ALC Course Standards, Leadership Award, Distinguished Honor/Honor Graduate, AA Degree

SFC: Exceeded SLC Course Standards, Leadership Award, Distinguished Honor/Honor Graduate, >90 college semester hours towards BS

MSG: Exceeded MLC Course Standards, Leadership Award, Distinguished Honor Graduate, BS Degree

Highly qualified looks like:

SSG: Exceeded ALC Course Standards, Commandant's List, >60 college semester hours

SFC: Exceeded SLC Course Standards, Commandant's List, AA Degree

MSG: Exceeded MLC Course Standards, Commandant's List, >90 college semester hours towards BS Degree



MOS 68W

ASSIGNMENTS (Broadening and Critical Leader Development) PROPONENT SPECIFIC CHALLENGING / HIGH RISK

SSG: Drill Sergeant, Instructor Writer, Recruiter, Security Forces Assistance Brigade Health Care NCO, Small Group Leader, SRU Squad Leader, **see 68W CLD POSITIONS slide 116 including NCOIC, Operations NCO**

SFC: Attaché, Equal Opportunity Advisor, Inspector General NCO, Observer Coach/Trainer (Project Warrior), Professional Development NCO, Recruiter, Security Forces Assistance Brigade, Senior Drill Sergeant, Senior Drill Sergeant Leader, SHARP Master Advocate, SARC, Senior Instructor Writer, Senior Training Developer Writer, Senior Small Group Leader, SRU Platoon Sergeant, **Detachment Sergeant, Operations NCO, NCOIC, Platoon Sergeant**

MSG: Equal Opportunity Advisor, Inspector General NCO, Security Forces Assistance Brigade, Senior Health Care NCO, Observer Coach Trainer/Project Warrior NCO, Senior Career Management NCO, **First Sergeant, Senior Health Care NCO, Operations NCO**

CSM/SGM: N/A



MOS 68W

TRAINING

Most-qualified looks like:

SSG: EFMB, Nationally Registered Paramedic, Ranger, Special Operations Combat Medic (ASI W1), Jumpmaster

SFC: EFMB, Nationally Registered Paramedic, Ranger, Special Operations Combat Medic (ASI W1), Jumpmaster

MSG: EFMB, Nationally Registered Paramedic, Ranger, Special Operations Combat Medic (ASI W1), Jumpmaster

Highly qualified looks like:

SSG: Air Assault, Airborne, Advanced EMT, MRT, SHARP, EOL, MFT

SFC: Air Assault, Airborne, Advanced EMT, SHARP, EOL, MFT, Battle Staff

MSG: Air Assault, Airborne, Advanced EMT, MRT, MFT, Battle Staff

OTHER INDICATORS

Most-qualified looks like:

SSG: Active Audie Murphy or SGT Morales Club Member, awarded MOVSM for volunteer service, Army Best Medic Competitor, NCO of the Quarter/Year (**all annotated on NCOER**)

SFC: Active Audie Murphy or SGT Morales Club Member, awarded MOVSM for volunteer service, Army Best Medic Competitor, NCO of the Quarter/Year (**all annotated on NCOER**)

MSG: Award of the Order of Military Medical Merit (Regimental Award), Other Regimental Awards (**annotated on NCOER**)



MOS 68W

FULLY-QUALIFIED (MANDATORY)

Established requirements from Federal/ DoD/Legislative Authorities

SSG: Nationally Registered Emergency Medical Technician (Basic), National Registry of Emergency Medical Technicians

SFC: Nationally Registered Emergency Medical Technician (Basic), National Registry of Emergency Medical Technicians

MSG: N/A

CSM/SGM: N/A



U.S. ARMY

MOS 68X Progression Chart

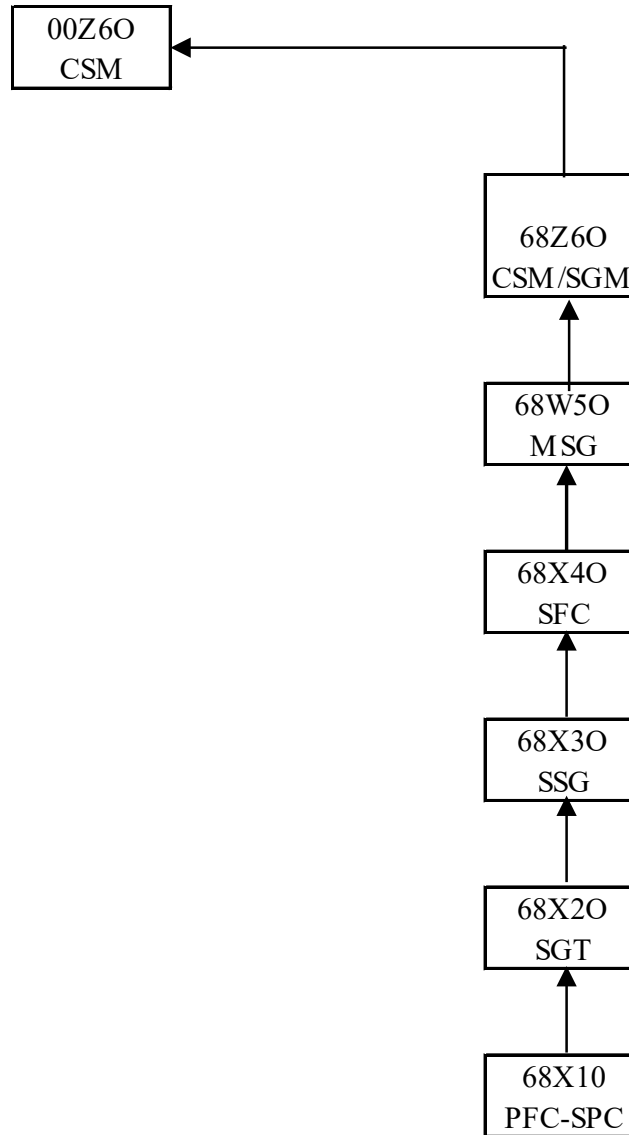



68X Talent Development Model (Merges into 68W at E8/MSG)

Years of Service	2	4	6	8	10	12	14	16	18	20	22	24	26	28
Rank														
Key Leadership Position	BEHAVIORAL HEALTH SPEC		BEHAVIORAL HEALTH SGT BEHAVIORAL HEALTH NCO TEAM CHIEF		BEHAVIORAL HEALTH NCO INSTRUCTOR SQUAD LEADER DRILL SERGEANT RECRUITER		SR BEHAVIORAL HEALTH NCO BEHAVIORAL HEALTH NCO DETACHMENT SERGEANT INSTRUCTOR							
Military/Civilian Education	DLC I		DLC II		DLC III		DLC IV							
	BLC		ALC		SLC		MLC							
	30 SEMESTER HOURS				ASSOCIATE DEGREE									
	REGISTERED BEHAVIOR TECHNICIAN (RBT), BEHAVIOR ANALYST CERTIFICATION BOARD (BACB), AMERICAN MEDICAL CERTIFICATION ASSOCIATION (AMCA), MENTAL HEALTH TECHNICIAN CERTIFICATION (MHTC)													
Critical Leadership Development	<div style="border: 1px solid red; padding: 5px; text-align: center; color: red;">OPERATIONS NCO, NCOIC</div> <div style="display: flex; justify-content: space-around; margin-top: 10px;"> <div style="border: 1px solid red; padding: 5px; text-align: center; color: red;">SECTION LEADER / SQUAD LEADER</div> <div style="border: 1px solid red; padding: 5px; text-align: center; color: red;">DETACHMENT SERGEANT PLATOON SERGEANT</div> </div>													
Broadening Opportunities	<div style="background-color: yellow; padding: 5px; text-align: center;">RECRUITER</div> <div style="display: flex; justify-content: space-between; margin-top: 10px;"> <div style="background-color: yellow; padding: 5px; text-align: center;">DRILL SERGEANT</div> <div style="background-color: yellow; padding: 5px; text-align: center;"> SDS, SDS LEADER, SGL, SSGL, SRU PSG, OC/T, ATTACHÉ, EOA, MEO INSTRUCTOR, IG NCO, SARC, SHARP MASTER ADVOCATE, CHIEF INSTRUCTOR/WRITER, CHIEF TRAINING DEVELOPER/WRITER, SENIOR INSTRUCTOR/WRITER, SENIOR TRAINING DEVELOPER/WRITER </div> </div> <div style="background-color: yellow; padding: 5px; text-align: center; margin-top: 10px;"> INSTRUCTOR/WRITER, SGL, SOLDIER RECOVERY UNIT (SRU) SQUAD LEADER </div>													
Military Training	<div style="background-color: lightgreen; padding: 5px; text-align: center;">EXPERT FIELD MEDICAL BADGE, AIR ASSAULT, AIRBORNE, RANGER</div> <div style="background-color: lightgreen; padding: 5px; text-align: center; margin-top: 10px;">EOL, UPL, MRT, MFT</div> <div style="background-color: lightgreen; padding: 5px; text-align: center; margin-top: 10px;">BATTLE STAFF, P3T LEADER</div>													



MOS 68X

The Behavioral Health Specialist, under the supervision of a psychiatrist, social worker, psychiatric nurse, psychologist, assists with the management and treatment in/out-patient mental health activities, during peace time or mobilization; collects and records psychosocial and physical data; counsels and treats clients/patients with personal, behavioral or mental health problems.

LEADERSHIP POSITIONS

Most-qualified looks like:

SSG: 24 to 48 months as a Squad Leader, Section Sergeant, NCOIC, Behavioral Health NCO

SFC: 24 to 36 months as a Platoon Sergeant, Detachment Sergeant

MSG: N/A

Highly qualified looks like:

SSG: Behavioral Health NCO

SFC: Senior Behavioral Health NCO

MSG: N/A



MOS 68X

PHYSICAL FITNESS

Most-qualified looks like:

SSG: 540 ACFT score or above with 90 points in each event

SFC: 540 ACFT score or above with 90 points in each event

MSG: N/A

Highly qualified looks like:

SSG: 480 ACFT score or above with 80 points in each event

SFC: 480 ACFT score or above with 80 points in each event

MSG: N/A

MILITARY/CIVILIAN EDUCATION

Most-qualified looks like:

SSG: Exceeded ALC Course Standards, Leadership Award, Distinguished Honor/Honor Graduate, AA Degree

SFC: Exceeded SLC Course Standards, Leadership Award, Distinguished Honor/Honor Graduate, BS Degree

MSG: N/A

Highly qualified looks like:

SSG: Exceeded ALC Course Standards, Commandant's List, >60 college semester hours

SFC: Exceeded SLC Course Standards, Commandant's List, AA Degree

MSG: N/A



MOS 68X

ASSIGNMENTS (Broadening and Critical Leader Development)
PROPONENT SPECIFIC CHALLENGING / HIGH RISK

SSG: Drill Sergeant, Instructor Writer, Recruiter, Small Group Leader, SRU Squad Leader, NCOIC, Operations NCO, Section/Squad Leader

SFC: Attaché, Equal Opportunity Advisor, Inspector General NCO, Observer Coach/Trainer, Recruiter, Senior Drill Sergeant, Senior Drill Sergeant Leader, SHARP Master Advocate, SARC, Senior Instructor Writer, Senior Training Developer Writer, Senior Small Group Leader, SRU Platoon Sergeant, Detachment Sergeant, Operations NCO, NCOIC, Platoon Sergeant

MSG: N/A



MOS 68X

TRAINING

Most-qualified looks like:

SSG: EFMB, National Certified Psychiatric Technician

SFC: EFMB, National Certified Psychiatric Technician

MSG: N/A

Highly qualified looks like:

SSG: Air Assault, Airborne, EOL, MFT, MRT, SHARP, P3T Leader

SFC: Air Assault, Airborne, Battle Staff, EOA, MFT, MRT, SHARP, P3T Leader

MSG: N/A

OTHER INDICATORS

Most-qualified looks like:

SSG: Active Audie Murphy or SGT Morales Club Member, awarded MOVSM for volunteer service, Army Best Medic Competitor, NCO of the Quarter/Year (**all annotated on NCOER**)

SFC: Active Audie Murphy or SGT Morales Club Member, awarded MOVSM for volunteer service, Army Best Medic Competitor, NCO of the Quarter/Year (**all annotated on NCOER**)

MSG: N/A



U.S. ARMY

MOS 68Y Progression Chart

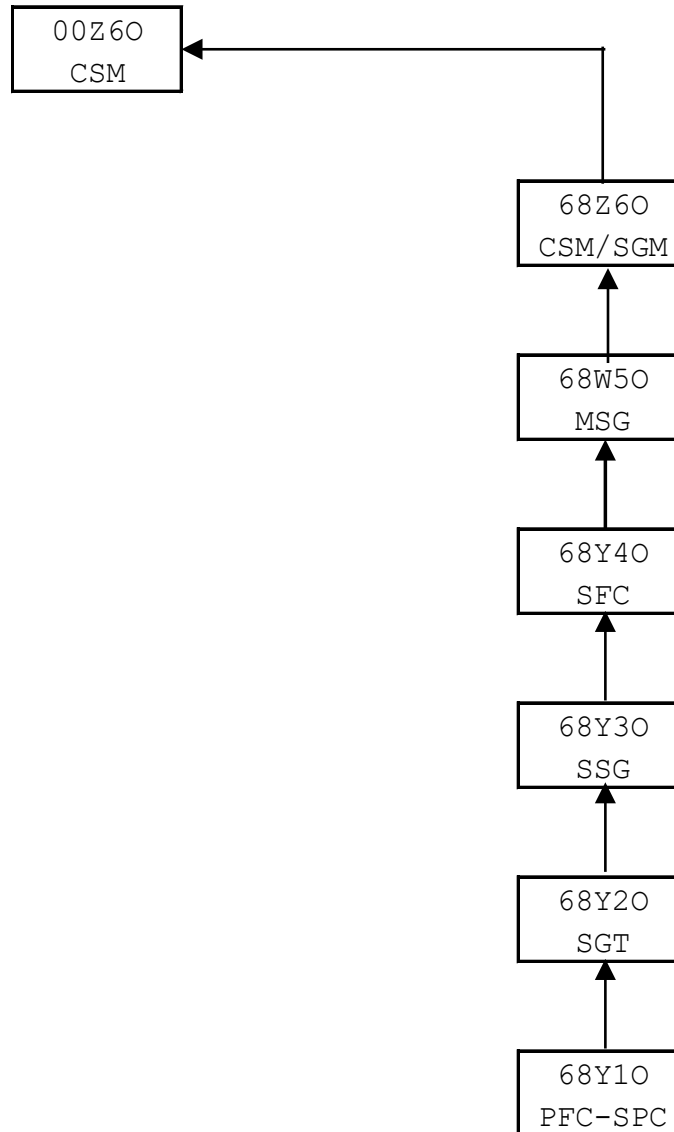



U.S. ARMY

68Y Talent Development Model (Merges into 68W at E8/MSG)

Years of Service	2	4	6	8	10	12	14	16	18	20	22	24	26	28									
Rank																							
Key Leadership Position	EYE SPEC		EYE SGT		EYE SGT MEDICAL NCO INSTRUCTOR INSTRUCTOR/WRITER			EYE NCO DETACHMENT SGT INSTRUCTOR INSTRUCTOR/WRITER															
Military/Civilian Education	DLC I		DLC II		DLC III		DLC IV			BLC					ALC		SLC		MLC				
	30 SEMESTER HOURS				ASSOCIATE DEGREE										CERTIFIED OPHTHALMIC ASSISTANT (COA), CERTIFIED OPHTHALMIC TECHNICIAN (COT), CERTIFIED OPHTHALMIC MEDICAL TECHNOLOGIST (COMT)								
Critical Leadership Development					OPERATIONS NCO, NCOIC										SECTION LEADER / SQUAD LEADER		DETACHMENT SERGEANT PLATOON SERGEANT						
Broadening Opportunities	RECRUITER										DRILL SERGEANT				SDS, SDS LEADER, SGL, SSGL, SRU PSG, OC/T,					ATTACHÉ, EOA, MEO INSTRUCTOR, IG NCO, SARC, SHARP MASTER ADVOCATE, CHIEF INSTRUCTOR/WRITER, CHIEF TRAINING DEVELOPER/WRITER, SENIOR INSTRUCTOR/WRITER, SENIOR TRAINING DEVELOPER/WRITER			
	INSTRUCTOR/WRITER, SGL, SOLDIER RECOVERY UNIT (SRU) SQUAD LEADER																						
Military Training	EXPERT FIELD MEDICAL BADGE, AIR ASSAULT, AIRBORNE, RANGER																						
	EOL, UPL, MRT, MFT										BATTLE STAFF, P3T LEADER												



MOS 68Y

The Eye Specialist supervises or conducts routine diagnostic tests and assists in the care and treatment of ophthalmology or optometry patients.

LEADERSHIP POSITIONS

Most-qualified looks like:

SSG: 24 to 48 months as a Squad Leader, Section Sergeant, NCOIC, Eye NCO

SFC: 24 to 36 months as a Platoon Sergeant, Detachment Sergeant

MSG: N/A

Highly qualified looks like:

SSG: Eye SGT

SFC: Senior Eye NCO

MSG: N/A



MOS 68Y

PHYSICAL FITNESS

Most-qualified looks like:

SSG: 540 ACFT score or above with 90 points in each event

SFC: 540 ACFT score or above with 90 points in each event

MSG: N/A

Highly qualified looks like:

SSG: 480 ACFT score or above with 80 points in each event

SFC: 480 ACFT score or above with 80 points in each event

MSG: N/A

MILITARY/CIVILIAN EDUCATION

Most-qualified looks like:

SSG: Exceeded ALC Course Standards, Leadership Award, Distinguished Honor/Honor Graduate, AA Degree

SFC: Exceeded SLC Course Standards, Leadership Award, Distinguished Honor/Honor Graduate, BS Degree

MSG: N/A

Highly qualified looks like:

SSG: Exceeded ALC Course Standards, Commandant's List, >60 college semester hours

SFC: Exceeded SLC Course Standards, Commandant's List, AA Degree

MSG: N/A



MOS 68Y

ASSIGNMENTS (Broadening and Critical Leader Development)
PROPONENT SPECIFIC CHALLENGING / HIGH RISK

SSG: Drill Sergeant, Instructor Writer, Recruiter, Small Group Leader, SRU Squad Leader, NCOIC, Operations NCO, Section/Squad Leader

SFC: Attaché, Equal Opportunity Advisor, Inspector General NCO, Observer Coach/Trainer, Recruiter, Senior Drill Sergeant, Senior Drill Sergeant Leader, SHARP Master Advocate, SARC, Senior Instructor Writer, Senior Training Developer Writer, Senior Small Group Leader, SRU Platoon Sergeant, Detachment Sergeant, Operations NCO, NCOIC, Platoon Sergeant

MSG: N/A



MOS 68Y

TRAINING

Best-qualified looks like:

SSG: EFMB, Certified Ophthalmic Assistant (COA)

SFC: EFMB, Certified Ophthalmic Assistant (COA)

MSG: N/A

Highly qualified looks like:

SSG: Air Assault, Airborne, EOL, MFT, MRT, SHARP, P3T Leader

SFC: Air Assault, Airborne, Battle Staff, EOA, MFT, MRT, SHARP, P3T Leader

MSG: N/A

OTHER INDICATORS

Best-qualified looks like:

SSG: Active Audie Murphy or SGT Morales Club Member, awarded MOVSM for volunteer service, Army Best Medic Competitor, NCO of the Quarter/Year **(all annotated on NCOER)**

SFC: Active Audie Murphy or SGT Morales Club Member, awarded MOVSM for volunteer service, Army Best Medic Competitor, NCO of the Quarter/Year **(all annotated on NCOER)**

MSG: N/A



U.S. ARMY

MOS 68Z Progression Chart

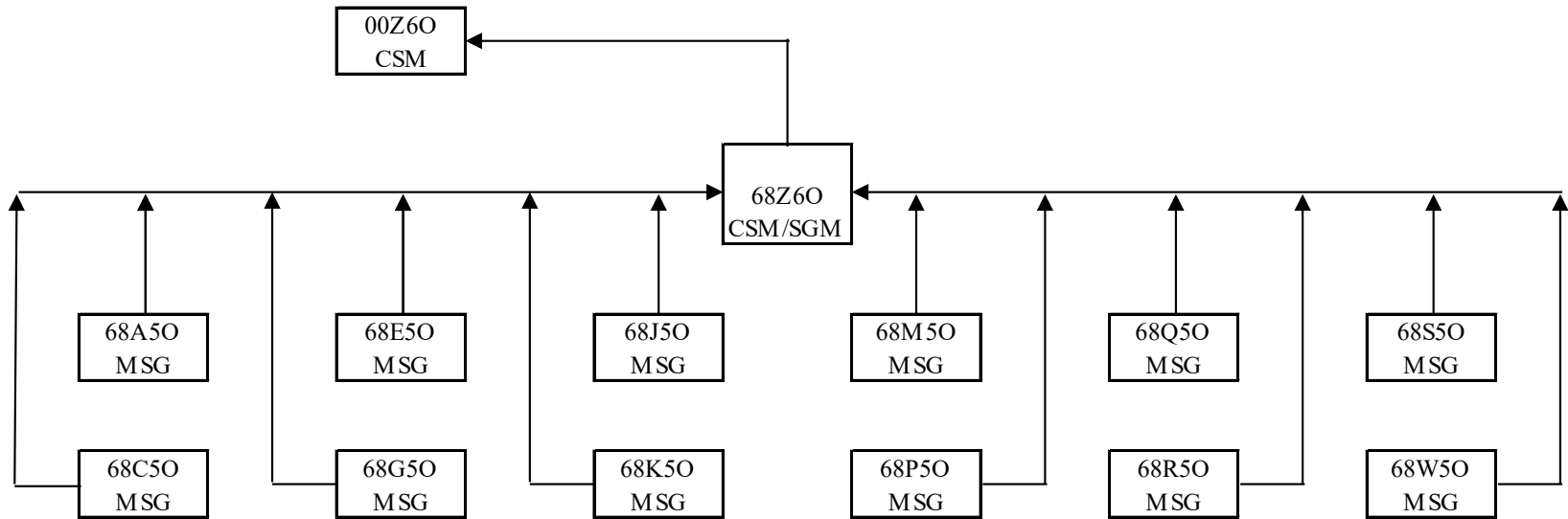



68Z Talent Development Model

Years of Service

2 4 6 8 10 12 14 16 18 20 22 24 26 28

Rank	
Key Leadership Position	<p>COMMAND SERGEANT MAJOR OPERATIONS SERGEANT MAJOR CHIEF MEDICAL NCO CHIEF INSTRUCTOR/WRITER</p>
Military/Civilian Education	<p>DLC VI NLC MASTER'S DEGREE</p>
Critical Leadership Development	<p>AMEDD PERSONNEL PROPONENT DIRECTORATE CAPABILITIES DEVELOPMENT & INTEGRATION DIRECTORATE CONGRESSIONAL LIAISON (OTSG) DIRECTORATE OF COMBAT MEDIC SPECIALIST TRAINING DIRECTORATE OF TRAINING AND ACADEMIC AFFAIRS</p>
Broadening Opportunities	<p>68Z ASSIGNMENT MANAGER CHIEF INSTRUCTOR/WRITER HRC, HSD-EB SGM PROPONENT SGM EO SGM IG SGM NCOLCoE FACULTY ADVISOR</p>
Military Training	<p>BN/BDE PRE-COMMAND COURSE CSM DEVELOPMENT PROGRAM NCOLCoE & USASMA FELLOWSHIP PROGRAM U.S. ARMY CONGRESSIONAL FELLOWSHIP PROGRAM</p> <p>ENLISTED JOINT PROFESSIONAL MILITARY EDUCATION (EJPME) II</p> <p>IG, EO, SHARP</p>



MOS 68Z

1. The chief medical NCO is the principal Noncommissioned officer who supervises, and performs related duties as the senior advisor to Commanders, Directors, and Chiefs of Departments and staff agencies on all matters pertaining to enlisted personnel. They perform these duties in multifunctional medical treatment facilities and medical staff activities, or in medical units formed under the Table of Organization and Equipment (TOE), or Table of Distribution and Allowances (TDA) concept.
2. The chief medical NCO must be qualified in one of the following twelve MOS (68A, 68C, 68E, 68G, 68J, 68K, 68M, 68P, 68Q, 68R, 68S, and 68W) at the grade of MSG.

LEADERSHIP POSITIONS

Most-qualified looks like:

MSG: see respective MOS supplement (68A, 68C, 68E, 68G, 68J, 68K, 68M, 68P, 68Q, 68R, 68S, and 68W)

CSM/SGM: Chief Medical NCO, Operations SGM, Command Sergeant Major

Highly qualified looks like:

MSG: see respective MOS supplement (68A, 68C, 68E, 68G, 68J, 68K, 68M, 68P, 68Q, 68R, 68S, and 68W)

CSM/SGM: Chief Medical NCO, Operations SGM, Command Sergeant Major



MOS 68Z

PHYSICAL FITNESS

Most-qualified looks like:

MSG: 540 ACFT score or above with 90 points in each event

CSM/SGM: 540 ACFT score or above with 90 points in each event

Highly qualified looks like:

MSG: 480 ACFT score or above with 80 points in each event

CSM/SGM: 480 ACFT score or above with 80 points in each event

MILITARY/CIVILIAN EDUCATION

Most-qualified looks like:

MSG: Exceeded MLC Course Standards, Leadership Award, Distinguished Honor/Honor Graduate, Masters Degree

CSM/SGM: Exceeded USASMA Course Standards, Leadership Award, Distinguished Honor/Honor Graduate, Battalion/Brigade Pre-Command Course, Masters Degree

Highly qualified looks like:

MSG: Exceeded MLC Course Standards, Commandant's List, >90 semester hours towards BS Degree

CSM/SGM: Exceeded USASMA Course Standards, Commandant's List, Bachelors Degree



MOS 68Z

ASSIGNMENTS (Broadening and Critical Leader Development)
PROPONENT SPECIFIC CHALLENGING / HIGH RISK

MSG: see respective MOS supplement (68A, 68C, 68E, 68G, 68J, 68K, 68M, 68P, 68Q, 68R, 68S, and 68W)

CSM/SGM: Chief Instructor/Writer, Chief Training Developer Writer, Assistant IG, AMEDD Personnel Proponent Directorate, Capabilities Development & Integration Directorate, Congressional Liaison (OTSG), Directorate of Combat Medic Specialist Training, Directorate of Training and Academic Affairs, Command Sergeant Major,



MOS 68Z

TRAINING

Most-qualified looks like:

MSG: EFMB, (See respective MOS Supplement for Certification information)

CSM/SGM: EFMB

Highly qualified looks like:

MSG: (See respective MOS Supplement)

CSM/SGM: EFMB

OTHER INDICATORS

Most-qualified looks like:

MSG: Award of the Order of Military Medical Merit (Regimental Award), Other Regimental Awards
(annotated on NCOER)

CSM/SGM: Award of the Order of Military Medical Merit (Regimental Award), Other Regimental Awards
(annotated on NCOER)